

Corporation of the County of Lanark

MUNICIPALITY OF MISSISSIPPI MILLS



STORMWATER MANAGEMENT
REPORT - PRELIMINARY

PROJECT: MENZIE ENCLAVES SUBDIVISION

ADDRESS:

ADELAIDE ST

MUNICIPALITY OF MISSISSIPPI MILLS, ON

PREPARED FOR:

13165647 Canada Inc
27 Queen Street East . #407,
Toronto, ON,
M5C 2M6

PREPARED BY:

Advance Engineering Ltd. Ottawa, ON
(613) 986 9170

<i>Date</i>	<i>Revision / Issue</i>
January 31, 2023	Issued for a Subdivision Draft Plan Application

TABLE OF CONTENTS

1.0 INTRODUCTION.....	2
1.2 SITE DESCRIPTION.....	2
1.3 BACKGROUND AND LAND USE.....	3
1.4 PROPOSED DEVELOPMENT AND PHASING.....	3
2.0 EXISTING CONDITIONS.....	4
2.1 TOPOGRAPHY / GEOLOGY.....	4
2.1 EXISTING DRAINAGE CONDITIONS.....	4
3.0 PROPOSED STORMWATER MANAGEMENT AND DRAINAGE.....	4
3.1 DESIGN CRITERIA.....	4
3.2 QUANTITY CONTROL REQUIREMENTS.....	5
3.2.1 Runoff Coefficient.....	5
3.2.2 Rainfall Intensity.....	6
3.2.3 Drainage Areas.....	6
3.2.4 Runoff Calculations.....	7
3.2.5 Allowable Release Rates.....	7
3.2.6 On-Site Storage & Flow Control.....	7
3.2.7 Hydrological and Hydraulic Modelling.....	8
3.2.8 Major System.....	8
3.3 QUALITY CONTROL REQUIREMENTS.....	9
4.0 EROSION AND SEDIMENT CONTROL MEASURES.....	9
4.1 TEMPORARY SEDIMENT CONTROL MEASURES.....	9
4.2 CONSTRUCTION SEQUENCING.....	10
4.3 INSPECTION & MAINTENANCE OF ALL THE EROSION AND SEDIMENT CONTROLS...10	
5.0 CONCLUSIONS AND RECOMMENDATIONS.....	10

List of Appendices:

- A – Location Figures
- B - Geotechnical Report (2022)
- C - Stormwater Design

Related Report: - Preliminary Site Servicing Report

List of Related Drawings: - Draft Plan of Subdivision

1.0 INTRODUCTION

13165647 Canada Inc. has retained Advance Engineering Ltd. to provide a stormwater management study, a site grading and drainage plan and an erosion and sediment control plan for the proposed residential subdivision of 50 semi-detached and 5 single detached lots. The report provides information and assumptions used in the design of the drainage system and storm sewer and should be read in conjunction with the design drawings prepared by Advance Engineering Ltd. The project site is located at the south west corner of Adelaide St and Menzie St intersection in the north side of the Municipality of Mississippi Mills, Ontario (Figure 1, **Appendix A**). The report is prepared in support of an application for a subdivision Draft Plan approval by the applicant.

1.1 OBJECTIVE AND STRATEGY

The objective of the stormwater management study is to develop a strategy that will:

- Identify and mitigate potential stormwater runoff negative impacts from the proposed development area on the receiving watercourses.
- Address the concerns from the review agencies including the Municipality of Mississippi Mills, the Corporation of the County of Lanark, the Ministry of Environment, Conservation and Parks (MECP) and the Mississippi Valley Conservation Authority (MVC) regarding solutions for stormwater management quantity and quality controls as well as erosion and sediment control.
- Design an appropriate site drainage system for safe operational use while minimizing post-development stormwater runoff.
- Determine the location and size of stormwater management components and structures located within the site.

The stormwater management will meet the requirements and criteria set out by MVC, Municipality of Mississippi Mills, and MECP in terms of applying quantity and quality controls. The City of Ottawa “Sewer Design Guidelines-2012” have been used in the drainage design. “Stormwater Management Planning and Design Manual” by the Ministry of the Environment, Conservation and Parks (MECP) has been used for stormwater management solutions.

1.2 SITE DESCRIPTION

The proposed development is on a single parcel of land. The legal description of the property is: “Park Lot 2, Block C, Henderson Section, And Lot 1 to 25 inclusive, Park Block C, McLean Section, And Alfred Street, And Alexandra Street, Registered Plan 6262, Former Town of Almonte, Municipality of Mississippi Mills, County of Lanark”. The site is bounded as follows:

- Adelaide St (unopened) and a future development (*Hannan Hills*) beyond to the north,
- Spring Creek and Menzie St (unopened) to the east,
- Augusta St (unopened) and Spring Creek beyond to the south, and,

- residential dwellings and McDermott St beyond to the west.

The subject property is approximately 2.8426 hectares (7.02 acres) with a rectangular shape of 185 m in length and 155 m in width. The site is currently vacant and covered with trees and tall grass.

1.3 BACKGROUND AND LAND USE

The site has never been developed. Under the Comprehensive Zoning By-Law #11-83, consolidated on March 10, 2020, a zoning amendment is required to change the zoning type of the site from “D” zoning to proposed “R1” and “R2” zonings.

The site has been surveyed by *Annis, O’Sullivan, Vollebekk Ltd.*, Job No.: 22733-22, field work completed October 31, 2022.

A copy of the report outlining the results of the geotechnical subsurface investigation is attached in **Appendix B**.

An *Environmental Impact Statement* has been conducted by *Gemtec*, Date December 16, 2022, Project reference: 101835.001.

The following documents have been provided by the Owner and Municipality staff:

1- “*Hannan Hills, Serviceability and Conceptual Stormwater Management Report*” dated May 20, 2021, by *Novatech*. File: 118201, Ref: R-2021-010.

2- “*Master Plan Update Report*” prepared by *J.L.Richards* for the Municipality of Mississippi Mills, dated February 2018, JLR No.: 27456-01

1.4 PROPOSED DEVELOPMENT AND PHASING

The proposed subdivision, as shown in the Draft Plan of Subdivision, includes semi-detached lots with attached garages with areas not less than 225 m² and frontages not less than 7.5 m (for each dwelling unit) and single detached lots with areas not less than 360 m² and lot frontages not less than 12 m. In addition to the residential lots, one block for stormwater management facility (Block 28) and two blocks for future road widening along Adelaide and Augusta have been proposed.

The development includes the construction of paved roadways, separate sanitary and storm sewers, watermains and other utilities (gas, Bell and Hydro) to service the proposed 55 lots. The project will be completed in one phase.

ROADWAY DESIGN

The subdivision has two road intersections with Adelaide St to the north. A 4 m wide pedestrian pathway is planned between internal Street A and Menzie St.

Proposed streets A and B will be constructed as per the typical road cross-section shown in the Draft Plan. The proposed 18-metre right-of-way will have 8.5-metre asphalt pavement and mountable curbs. A sidewalk will be constructed on one side of the subdivision streets.

As per the geotechnical report, roadway pavement structure shall consist of (from top to bottom):

- 40 mm HL3 or Superpave 12.5 asphaltic concrete wear course
- 50 mm HL8 or Superpave 19.0 asphaltic concrete wear course
- 150 mm base (OPSS Granular A crushed stone)
- 300 mm subbase (OPSS Granular B – Type II crushed stone)

Total thickness of 690 mm.

The subgrade will be either fill or in-situ soil or OPSS granular B type II placed over in-situ soil.

2.0 EXISTING CONDITIONS

2.1 TOPOGRAPHY / GEOLOGY

The site is relatively flat with slight slopes from west to east and south to north. Elevations are between 137.49 and 139.21 m (Geodetic Vertical Datum).

According to the geotechnical report No. PG6247-1 prepared by *Paterson Group*, dated July 19, 2022, the subsurface profile encountered at the test hole locations consisted of a layer of topsoil and/or peat underlain by marl and/or a glacial till deposit. The layer of topsoil and/or peat generally extended to an approximate depth between 0.1 and 0.4 m below ground surface. Practical refusal to excavation was encountered at all test holes at approximate depths ranging between 0.3 and 1.1 m below the existing ground surface.

Measured groundwater levels observed within test pits on May 26 and 27, 2022, vary from 0.30 to 0.75 m from the existing grade. Groundwater flows toward the *Mississippi River* located approximately 800 m south of the site.

2.1 EXISTING DRAINAGE CONDITIONS

The site is located within the sub-watershed of *Spring Creek*. There is a wetland north of the site, however MVC has advised that the wetland will be declassified to allow *Hannan Hills* development. There is no storm water sewer in the immediate area of the subdivision.

Under existing conditions, the majority of the site area drains east towards *Spring Creek*. The soil exhibits signs of regular saturation due to periodic inundation and ponding.

The creek is approximately 9 to 11 m wide along Menzie and 6 to 7.5 m along Augusta. The creek bottom elevations are 137.10 at the north east corner of the site and 136.04 at the south west corner.

There is an 1150 mm diameter CSP culvert crossing Menzie St at the south east corner of the site. Its invert elevations are 136.75 and 136.95. There is a 1500 mm diameter CSP culvert downstream the site crossing the unopened Florence St. Its invert elevations are 135.58 and 135.56. There are other smaller culverts along the creek crossing unopened Menzie St and Augusta St. The capacity of the existing watercourse and culverts have not been examined in this study as they are beyond the scope of work undertaken.

Existing drainage conditions and patterns have been illustrated in Drawing ST-1, **Appendix C**.

3.0 PROPOSED STORMWATER MANAGEMENT AND DRAINAGE

3.1 DESIGN CRITERIA

- Minor system drainage: designed for the 5 year storm event without street ponding; stormwater will be captured and conveyed via the proposed storm sewer (street and rear yard catchbasins, manholes and pipes) to the proposed stormwater detention structure. ICDs will be installed to prevent surcharging the sewer during major events.

- Major System: uses the road cross-section as an open channel for overland flows during major events.
 - Quantity control: post-development runoffs to match pre-development runoffs for the 1 or 5 and the 100 year storm events using the Rational Method and various design storms. Temporary storage will be provided in the stormwater management detention structure.
 - Quality control: an “Enhanced” level of treatment with minimum 80% of TSS (total suspended solids) removal is required for the minor system drainage as per MECP guidelines.
 - No surface drainage shall be directed toward neighbouring properties.
 - Hydraulic Grade Lines (HGL) for 100-year event to be kept at least 300 mm below the underside of footing elevations of the proposed dwelling units, otherwise houses shall be equipped with sumps.
 - 15 m buffer zone from watercourse bank along Menzie St: The buffer zone will not be included in the stormwater analysis since no vegetation or grading changes will occur in order to protect the creek eco-system.
 - Erosion and sediment control: Low Impact Development (LID) measures to be considered to retain, detain or infiltrate the first 5 mm of runoff from post-development impervious areas.
 - Culverts to be designed for 25 year storm event.

3.2 QUANTITY CONTROL REQUIREMENTS

As requested by the Conservation Authority, the target is to limit the maximum post-development runoff rate discharged from the site for all storm events, up to and including the 100-year design storm, to that of the pre-development runoff rates. The Rational Method has been used to estimate the pre-development and post-development runoffs.

3.2.1 Runoff Coefficient

Runoff Coefficient C	
Surface Type	C*
Impervious: Rooftop-Asphalt Pavement-Driveway	0.9
Road Shoulders	0.7
Grass-Cultivated-Pasture	0.2-0.4

* For Q_{100yr} add 25% to C value. For Q_{25yr} add 10% to C value

* Table 5.7 *Ottawa Sewer Design Guidelines – October 2012*

Table 1: Runoff Coefficient C

Pre-development runoff coefficient has been estimated at **0.25** as per *Ottawa Guidelines, Table 5.7*, for a woodland with slopes between 0% and 5%.

Post-development average runoff coefficient has been estimated at **0.57** (0.62 for 100y storm) and the impervious ratio at **0.50** based on surface nature and the maximum impervious surfaces

permitted by Zoning. Minimum block area is 450 m² and maximum lot coverage is 30%. The total housing area is 1.9101 ha not including the stormwater facility (0.1621 ha). Refer to **Appendix C** for detailed calculations of imperviousness ratio and weighted runoff coefficient for post-development condition.

3.2.2 Rainfall Intensity

Rainfall peak intensity formulas for the City of Ottawa have been used.

* 2 year rainfall intensity: $I_2 = (732.951)/((T_c + 6.199)^{0.810})$; where T_c = time of concentration in min

* 5 year rainfall intensity: $I_5 = (998.071)/((T_c + 6.053)^{0.814})$

* 25 year rainfall intensity: $I_{25} = (1402.884)/((T_c + 6.018)^{0.819})$

* 100 year rainfall intensity: $I_{100} = (1735.688)/((T_c + 6.014)^{0.82})$

* *Time of concentration*: depends mainly on soil roughness, terrain slope, rainfall intensity and longest runoff path. The farthest points to the outlet (watercourse) are 175 m for pre-development and 225 m for post-development including 40 m overland flow. Several formulas resulted in different values of T_c (see **Appendix C**). A conservative estimation for T_c is **15 min** for pre-development and **13 min** for post-development. Rainfall Intensities will be:

Pre-development: $I_2 = 61.77$ mm/hr ; $I_5 = 83.56$ mm/hr ; $I_{100} = 142.89$ mm/hr

Post-development: $I_2 = 66.93$ mm/hr ; $I_5 = 90.63$ mm/hr ; $I_{100} = 155.11$ mm/hr

3.2.3 Drainage Areas

Pre-development and post-development drainage areas are shown in the drawings **ST-1** and **ST-2** in **Appendix C** and are summarized as follows in Table 2 and Table 3:

Pre-development:

The topography of the site could be divided into two areas: A1 generally sloped to north-east and A2 sloped to south. Both areas outlet into the watercourse at different locations. The site surface is 100% pervious.

I/ PRE-DEVELOPMENT RUNOFF CALCULATION										
Catchment	ID	Area (ha)	Percent of Total Area	C		A x C (ha)	C relative	Q 2-year (L/s)	Q 5-year (L/s)	Q 100-year (L/s)
				2-5 y	100 y					
Trees / Grass	A1	2.0689	72.78	0.25	0.31	0.5172	0.18	88.8	120.1	256.8
Trees / Grass	A2	0.7737	27.22	0.25	0.31	0.1934	0.07	33.2	44.9	96.0
TOTAL (Buffer incl.)		2.8426	100%			0.7107		122	165	353
All Site – Buffer	At	2.6904		0.25	0.31	0.6726	0.24	115	156	334

Table 2 – Pre-Development (Existing) Drainage Areas

Post-development:

Excess flow beyond pre-development levels will be stored in the proposed detention structure in the open space (Block 28) in the south east side of the site, and will eventually be discharged

through an outlet control structure and outfall into the existing watercourse. No carryover runoff from adjacent properties is expected to occur. Adelaide St runoff will be included in *Hannan Hills* storm design.

Table 3 summarizes post-development drainage areas breakdown.

III/ POST-DEVELOPMENT RUNOFF CALCULATION – BUFFER ZONE NOT INCLUDED												
Catchment	ID	Area (ha)	Percent of Total Area (%)	C		A x C (ha)	C _{relative}	Q 2-year (L/s)	Q 5-year (L/s)	Q 100-year (L/s)	Q _{100y} by Control Measure (L/s)	
				2-5 y	100 y						CONT.	UNC.
All site (-) STM (-) Buffer	A1	2.5576	95.06	0.57	0.62	1.4578	0.542	271.3	367.3	684	684	
STM Facility	A2	0.1328	4.94	0.25	0.31	0.0332	0.012	6.2	8.4	18	18	
TOTAL		2.6904	100%			1.4910	0.55*	277	376	702	702	0

* C_{weighted} for 100y event = 0.60

Table 3: Proposed Post-Development Drainage Areas

3.2.4 Runoff Calculations

For the whole site not including the buffer zone, pre-development and post-development runoff peak flows are summarized as follows:

* **Rational Method:** $Q_{2yr, 5yr, 100yr} = 2.78 \cdot C \cdot I_{2yr, 5yr, 100yr}$

Pre-development peak flows:

$Q_{2yr, 5yr, 100yr} = 0.115 \text{ m}^3/\text{s}, 0.156 \text{ m}^3/\text{s}, 0.334 \text{ m}^3/\text{s}$

Post-development peak flows:

For the whole site: $Q_{2yr, 5yr, 100yr} = 0.277 \text{ m}^3/\text{s}, 0.376 \text{ m}^3/\text{s}, 0.702 \text{ m}^3/\text{s}$

3.2.5 Allowable Release Rates

The post-development allowable release rates will match pre-development rates calculated using the RM method or different storms.

3.2.6 On-Site Storage & Flow Control

The detention basin will limit the flow rates generated by major events. It will also function for 2 and 5-year events.

* *100-year event:* with an average runoff coefficient of 0.60 (100y), an area of 2.6904 ha and an allowable release rate of 0.334 m³/s, the required storage volume is estimated at 283 m³ using the “Modified Rational Method”. The simulation of the 4-hr Chicago Storm hydrograph derived from Ottawa IDF curves resulted in a volume of 608 m³.

* *5-year event:* with an average runoff coefficient of 0.55 and an allowable release rate of 0.156

m³/s, the required storage volume is estimated at 169 m³.

Proposed On-Site Detention Structure (Refer to **Appendix C** for pond details).

- Irregular shape with bottom length of 39 m approximately, bottom width of 19 m and depth of 1.7 m; a maximum volume capacity of 771 m³ at 1.6 m depth.
- Maximum interior embankment slopes: 3:1 and minimum bottom slope at 1%.
- Minimum 0.3 m freeboard to embankment crest.
- Emergency spillway on the watercourse side (south).
- A concrete outlet control structure with an opening (orifice) and a rectangular weir will be installed inside the pond as per details. A 450 mm diameter frost treated outlet pipe (culvert) will connect the outlet structure to the outfall at the watercourse.
- Minimum setback from creek: 15 m.
- 2 x 2 x 0.3 m Riprap apron at inlet location as per OPSD and scour protection at outfall.
- A chain-link fence will be installed surrounding the pond for safety purpose, and a 3.5 m-wide asphalt driveway will provide the access to the basin and outfall for maintenance.

Inlet control devices (ICDs): will be installed in catchbasins to restrict flow during major events.

3.2.7 Hydrological and Hydraulic Modelling

EPA SWMM 5.2 has been used for the hydrological modelling of stormwater using different design storms and hydrographs for pre-development and post-development conditions. The 4-hour Chicago Storm derived from Ottawa IDF's generates the highest peaks. Refer to **Appendix C** for all details. SWMM has been used in pond routing and sizing of an orifice and a weir designed to limit post-development peak flows to those of pre-development levels.

Infiltration losses for catchment areas have been modelled using Horton's infiltration equation and default values provided by City of Ottawa guidelines. Horton's Equation: $f(t) = f_c + (f_o - f_c)e^{-k(t)}$; where: initial infiltration rate: $f_o = 76.2$ mm/hr; final infiltration rate: $f_c = 13.2$ mm/hr; decay Coefficient: $k = 4.14$ /hr

Hydrology Toolbox 5.2 software has been used for the hydraulic design of culverts and inlets.

3.2.8 Major System

The total capacity of the minor system designed using the Rational Method for 5-year return period is estimated at 0.384 m³/s. Peak flows for 100-year events have been estimated using the Rational Method and the 4-hour Chicago Storm and are 0.702 m³/s and 0.783 m³/s respectively. The additional runoff will flow overland in the open roads outletting to the detention structure. The overland flow depth is not expected to exceed 0.3 m for a road slope of 0.5%.

3.3 QUALITY CONTROL REQUIREMENTS

Enhanced level of treatment (80% of TSS removal) is required to protect receiving waters. It will be achieved by the installation of a Stormceptor EFO8 by Imbrium or equivalent (**Appendix C**).

Moreover, LID measures and Best Management Practices (BMPs) will be implemented such as:

- Flattened grassed areas will increase the travel time and provide some quality enhancement to the stormwater before it reaches receiving sewer.
- All roof leaders from buildings shall be directed away from buildings toward the landscaped areas and grassed swales in order to promote infiltration.
- Vegetated or enhanced swales: helps by tracking pollutants such as heavy metals, lowering peak flows and reducing erosion.
- Sub-drains where low grades improve the quality of released water and increases infiltration.
- Storing water temporarily helps clean stormwater and control sediments.

4.0 EROSION AND SEDIMENT CONTROL MEASURES

The purpose of Erosion and Sediment Control (ESC) measures is to mitigate the adverse environmental impacts caused by the release of silt-laden stormwater runoff into receiving sewers and watercourses and to ensure that sediment is contained within the site. Temporary ESC measures will be implemented and maintained during construction period as specified in related drawings and in accordance with the requirements of latest provincial standards *OPSS 805*. They will be maintained in good order until vegetation has been re-established on the site. Permanent erosion problem can be mitigated by reducing the peak flow rate, decreasing the duration of storm flows, minimizing the volume of runoff, and implementing Low-Impact Development (LID) techniques in new construction.

4.1 TEMPORARY SEDIMENT CONTROL MEASURES

- Temporary silt fencing shall be placed prior to topsoil stripping and for the duration of the construction around the perimeter of the site and adjacent to any disturbed areas and surrounding topsoil stockpiles in order to prevent sediment from entering into the watercourse. It shall be inspected regularly and after every rainfall event for rips or tears, broken stakes, structural failure. Accumulated sediment/silt shall be removed when it reaches 50% of the height of the fence.
 - Mud-mats shall be constructed at all locations of access/egress to and from the site.
 - Straw bale and rock check dams shall be installed in any temporary drainage ditches required during the construction period.
 - All exposed soil and disturbed slopes shall be stabilized as soon as possible with a seed and mulch application
 - No construction activity or machinery shall intrude beyond the silt/snow fence or limit of construction area. All construction vehicles shall leave the site at designated locations.
 - All materials and equipment used for the purpose of site preparation and project completion should be operated and stored in a manner that prevents any deleterious substance from leaving the site or entering the water (silt, petroleum products, etc.).
 - Stockpiles of soil shall be set back of at least 15 m from any watercourse and stabilized

against erosion as soon as possible.

- Installation of sediment traps to prevent silt-laden runoff from entering the municipal sewer system during construction.

4.2 CONSTRUCTION SEQUENCING

The schedule of construction activities with respect to sediment controls are as follows:

- Installation of silt fences prior to any other activities on the site.
- Construction of temporary mud-mats at all construction access/egress.
- Installation of site servicing and underground utilities.
- Disposal of all the surplus excavated materials off site.
- Construction of roadways.
- Restoration / re-vegetation of disturbed areas either with temporary measures such as mulch or seeding or with final landscape and paving materials.
- All re-graded areas that are not occupied by buildings, sidewalks, or driveways shall be top-soiled and sodded/seeded immediately after completion of final grading operations.
- Erosion controls shall be kept in place and functional until the site is stabilized (lot grading and sodding complete).

4.3 INSPECTION & MAINTENANCE OF ALL THE EROSION AND SEDIMENT CONTROLS

Shall be undertaken with the following frequency:

- On a weekly basis
- After every rainfall event
- After significant snow melt events
- Prior to forecast rainfall events
- If damaged control measures are found, they should be repaired and/or replaced within 48 hrs.

5.0 CONCLUSIONS AND RECOMMENDATIONS

This report addresses the stormwater management and erosion control for the proposed residential subdivision development. The release of post-development stormwater is controlled to the pre-development levels for all storm events up to and including the 100-y event. Post-development excess stormwater will be stored in a detention basin located in the open space (Block 28) to be conceded to the Municipality.

Downstream capacity is not expected to be affected by the development since post-development peak flows will not exceed the current peak flows under undeveloped conditions.

Backwater valves will be installed on both sanitary and storm laterals. Homes located at the south east side of the site may not be able to connect foundation drains directly to the storm sewer.

Catchbasins will be equipped with inlet control devices (ICD) to prevent sewer surcharge.

MENZIE ENCLAVES SUBDIVISION
MISSISSIPPI MILLS, ONTARIO
STORMWATER MANAGEMENT REPORT

The flattened lot grading will help improve infiltration on-site. BMPs measures will be implemented in order to help attenuate negative impacts on downstream infrastructures.

To achieve the required quality of the released storm water, a Stormceptor EFO8 will be installed upstream the detention structure.

The owner understands that it is his duty to keep stormwater management control structures in good working order until transfer of ownership to the Municipality.

All outlets to watercourses and open ditches require a permit from the Conservation Authority prior to any development of the lot, including grading and placement of fill.

The drainage of Adelaide St will be coordinated with *Hannan Hill* development team.

During all construction activities, erosion and sedimentation shall be controlled as outlined in this report and shown in associated drawings.

Respectfully submitted,

Mongi Mabrouk M.Eng., P.Eng.

Advance Engineering Ltd.



APPENDICES

Appendix A

- Figure 1: Site Location

Appendix B

- Geotechnical Report

Appendix C

- Drawing ST-1: Pre-development Drainage Areas
- Drawing ST-2: Post-development Drainage Areas
- Runoff Coefficient Calculations
- Allowable Release Rate
- Required Storage Calculation
- Storm Sewer Design Sheet
- Stormceptor documentation

APPENDIX - A

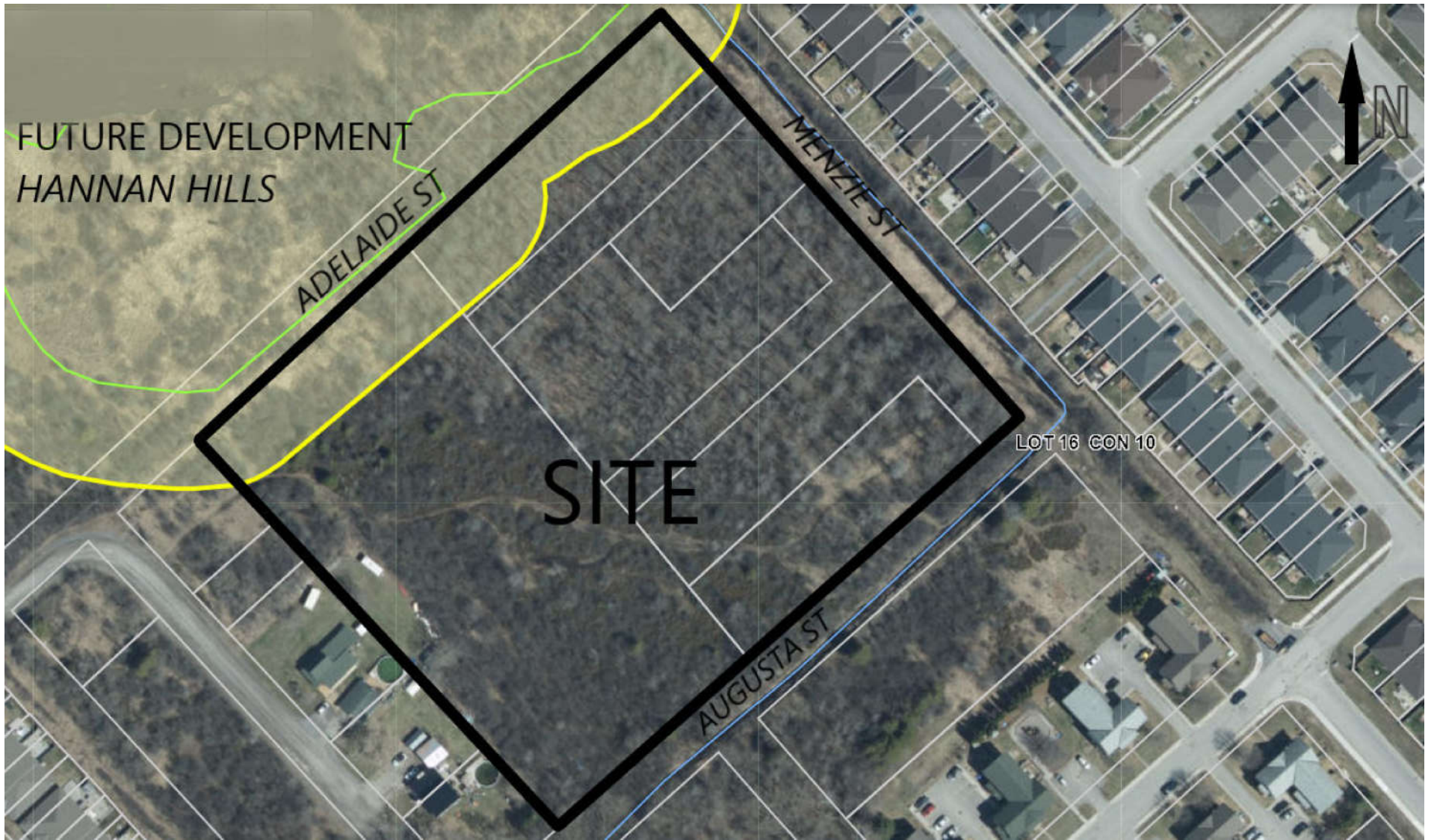

FIGURE 1



FIGURE 2

APPENDIX - B

Geotechnical Investigation

Proposed Residential Development

Adelaide Street at Menzie Street
Mississippi Mills, Ontario

Prepared for 13165647 Canada Inc.

Report PG6247-1 dated July 19, 2022

Table of Contents

	PAGE
1.0 Introduction	1
2.0 Proposed Development.....	1
3.0 Method of Investigation	2
3.1 Field Investigation	2
3.2 Field Survey	3
3.3 Laboratory Testing	3
3.4 Analytical Testing	3
4.0 Observations	4
4.1 Surface Conditions.....	4
4.2 Subsurface Profile.....	4
4.3 Groundwater	5
5.0 Discussion	6
5.1 Geotechnical Assessment.....	6
5.2 Site Grading and Preparation.....	6
5.3 Foundation Design	8
5.4 Design for Earthquakes.....	10
5.5 Basement Slab/ Slab-on-Grade Construction	10
5.6 Basement Wall.....	11
5.7 Pavement Design.....	12
6.0 Design and Construction Precautions.....	14
6.1 Foundation Drainage and Backfill	14
6.2 Protection of Footings Against Frost Action	14
6.3 Excavation Side Slopes	15
6.4 Pipe Bedding and Backfill	15
6.5 Groundwater Control.....	16
6.6 Winter Construction.....	17
6.7 Corrosion Potential and Sulphate.....	17
7.0 Recommendations	18
8.0 Statement of Limitations.....	19

Appendices

- Appendix 1** Soil Profile and Test Data Sheets
 Symbols and Terms
 Analytical Testing Results
- Appendix 2** Figure 1 - Key Plan
 Drawing PG6247-1 - Test Hole Location Plan

1.0 Introduction

Paterson Group (Paterson) was commissioned by 13165647 Canada Inc. to conduct a geotechnical investigation for the proposed residential development to be located at the southwest corner of Adelaide Street and Menzie Street in the Town of Mississippi Mills, Ontario (refer to Figure 1 - Key Plan in Appendix 2 of this report).

The objectives of the geotechnical investigation were to:

- Determine the subsoil and groundwater conditions at this site by means of test holes.
- Provide geotechnical recommendations pertaining to the design of the proposed development including construction considerations which may affect the design.

The following report has been prepared specifically and solely for the aforementioned project which is described herein. It contains our findings and includes geotechnical recommendations pertaining to the design and construction of the subject development as they are understood at the time of writing this report.

Investigating the presence or potential presence of contamination on the subject property was not part of the scope of work of the present investigation. Therefore, the present report does not address environmental issues.

2.0 Proposed Development

Based on the available drawings, it is understood that the proposed residential development will consist of a series of single- and semi-detached dwellings consisting of either basement or slab-on-grade construction and attached garages.

Associated access lanes, walkways, and landscaped areas are also anticipated as part of the development. It is expected that the proposed development will be municipally serviced.

3.0 Method of Investigation

3.1 Field Investigation

Field Program

The field program for the current geotechnical investigation was carried out on May 26 and 27, 2022, and consisted of 16 test pits which were advanced to a maximum depth of 1.1 m below the existing ground surface. The test hole locations were distributed in a manner to provide general coverage of the subject site, taking into consideration underground utilities and site features. The test hole locations are shown on Drawing PG6247-1 - Test Hole Location Plan included in Appendix 2.

The test pits were advanced using a hydraulic shovel excavator. All fieldwork was conducted under the full-time supervision of Paterson personnel under the direction of a senior engineer. The test pit procedure consisted of excavating to the required depths at the selected locations and sampling the overburden. The test pits were backfilled with the excavated soils upon completion.

Sampling and In Situ Testing

Soil samples obtained from the test pits were recovered from the sidewalls of the open excavation. The samples were classified on site, placed in sealed plastic bags, and transported to our laboratory. The depths at which the grab samples were recovered from the test pits are shown as G on the Soil Profile and Test Data sheets in Appendix 1.

Undrained shear strength testing, using a test-pitting vane apparatus, was carried out at regular intervals of depth in cohesive soils.

The subsurface conditions observed in the boreholes were recorded in detail in the field. The soil profiles are logged on the Soil Profile and Test Data sheets presented in Appendix 1.

Groundwater

Open hole groundwater infiltration levels were observed and recorded at the time of excavation in test pit locations where groundwater was present. Groundwater level observations are discussed in Section 4.3 and are presented in the Soil Profile and Test Data sheets in Appendix 1 of this report.

Sample Storage

All samples will be stored in the laboratory for a period of one (1) month after issuance of this report. They will then be discarded unless we are otherwise directed.

3.2 Field Survey

The test hole locations were selected by Paterson to provide general coverage of the proposed development taking into consideration the existing site features and underground utilities. The test hole locations and ground surface elevation at each test hole location were surveyed by Paterson using a handheld GPS and referenced to a geodetic datum. The locations of the boreholes and ground surface elevation at each test hole location are presented on Drawing PG6247-1 - Test Hole Location Plan in Appendix 2.

3.3 Laboratory Testing

Soil samples were recovered from the subject site and visually examined in our laboratory to review the results of the field logging. Soil samples will be stored for a period of one month after this report is completed, unless otherwise directed.

3.4 Analytical Testing

One (1) soil sample was submitted for analytical testing to assess the corrosion potential for exposed ferrous metals and the potential of sulphate attacks against subsurface concrete structures. The sample was submitted to determine the concentration of sulphate and chloride, the resistivity, and the pH of the samples. The results are presented in Appendix 1 and are discussed further in Section 6.7.

4.0 Observations

4.1 Surface Conditions

The subject site is currently undeveloped and mostly forested. The site is transected by a tree-cleared trail. The site is bordered by ditches along the east and south property boundaries and further by a residential subdivision, a vacant property to the north and residential dwellings to the west, followed by McDermott Street. The ground surface across the site is relatively flat and at grade with the surrounding properties.

4.2 Subsurface Profile

Overburden

Generally, the subsurface profile encountered at the test hole locations consisted of a layer of topsoil and/or peat underlain by marl and/or a glacial till deposit. The layer of topsoil and/or peat generally extended to an approximate depth between 0.1 and 0.4 m below ground surface.

The marl was generally encountered directly below the peat layer throughout the north and northeast portions of the subject site. The marl layer extended to approximate depths ranging between 0.4 and 0.8 m below ground surface. At the location of TP12-22 and TP14-22, the marl was further underlain by a glacial till deposit.

Where encountered, the glacial till deposit was observed at depths ranging between approximately 0.1 to 0.7 m below the existing ground surface. The glacial till deposit was observed to consist of brown silty clay and/or sandy silt, and varying amounts of gravel, cobbles, and boulders.

Practical refusal to excavation was encountered at all test holes at approximate depths ranging between 0.3 and 1.1 m below the existing ground surface.

Reference should be made to the Soil Profile and Test Data sheets in Appendix 1 for the details of the soil profile encountered at each test hole location.

Bedrock

Based on available geological mapping, the bedrock in the subject area consists of interbedded limestone and dolomite of the Gull River formation, with an overburden drift thickness of 0 to 2 m depth.

4.3 Groundwater

Groundwater infiltration levels were observed within the test pits during the excavation. The observed groundwater sidewall infiltration levels are presented in Table 1 below and on the Soil Profile and Test Data sheets in Appendix 1.

Table 1 – Summary of Groundwater Levels				
Borehole Number	Ground Surface Elevation (m)	Measured Groundwater Level		Date Recorded
		Depth (m)	Elevation (m)	
TP 1-22	138.22	0.50	137.72	May 26, 2022
TP 2-22	138.65	Dry	N/A	
TP 3-22	138.18	Dry	N/A	
TP 4-22	138.57	Dry	N/A	
TP 5-22	138.69	Dry	N/A	
TP 6-22	138.31	Dry	N/A	
TP 7-22	138.00	0.75	137.25	
TP 8-22	137.88	0.70	137.18	
TP 9-22	137.79	0.55	137.24	May 27, 2022
TP 10-22	138.05	Dry	N/A	
TP 11-22	137.91	0.30	137.61	
TP 12-22	137.79	0.30	137.49	
TP 13-22	137.92	0.45	137.47	
TP 14-22	138.03	0.40	137.63	
TP 15-22	137.97	0.40	137.57	
TP 16-22	138.27	Dry	N/A	

Note: The ground surface elevation at each test pit location was surveyed using a handheld GPS and referenced to a geodetic datum.

Long-term groundwater levels can also be estimated based on the observed colour and consistency of the recovered soil samples. Based on these observations, it is estimated that the long-term groundwater table can be expected below the bedrock surface.

It should be noted that groundwater levels are subject to seasonal fluctuations. Therefore, the groundwater level could vary at the time of construction.

5.0 Discussion

5.1 Geotechnical Assessment

From a geotechnical perspective, the subject site is considered suitable for the proposed residential development. The proposed buildings may be founded on conventional spread footings placed on an undisturbed glacial till, or a clean, surface sounded bedrock bearing surface.

Depending on the founding depth of the proposed buildings, bedrock removal may be required to complete the basement level and/or site servicing works. All contractors should be prepared for oversized boulder and bedrock removal.

The above and other considerations are further discussed in the following sections.

5.2 Site Grading and Preparation

Stripping Depth

Topsoil and deleterious fill, such as those containing significant amounts of organic materials, should be stripped from under any buildings, paved areas, pipe bedding and other settlement sensitive structures.

Fill Placement

Fill placed for grading beneath the proposed development should consist, unless otherwise specified, of clean imported granular fill, such as Ontario Provincial Standard Specifications (OPSS) Granular A or Granular B Type II. This material should be tested and approved prior to delivery to the site. The fill, where required, should be placed in lifts no greater than 300 mm thick and compacted using suitable compaction equipment for the lift thickness. Fill placed beneath the buildings and paved areas should consist of OPSS Granular A or Granular B Type II and be compacted to at least 98% of the material's standard Proctor maximum dry density (SPMDD).

Site-excavated soil may be used as general landscaping fill where settlement of the ground surface is of minor concern. The materials should be spread in lifts with a maximum thickness of 300 mm and compacted by the tracks of the spreading equipment to minimize voids. If this material is to be used to build up the subgrade level for areas to be paved, it should be compacted in thin lifts to at least 95% of the material's SPMDD.

Site-generated topsoil, peat and/or marl should be segregated from site-generated fill considered for use to build up subgrade levels. This material is generally considered unsuitable for use where load bearing and/or settlement sensitive structures such as roadways, services and other structures may be considered.

Site-excavated soils are not suitable for use as backfill against foundation walls unless used in conjunction with a composite drainage membrane, such as Miradrain G100N or Delta Drain 6000.

If excavated rock is used as exterior fill, it should be suitably fragmented to produce a well-graded material, similar to a 150 mm minus crushed stone material and approved by the geotechnical consultant. This material should be used structurally only to build up the subgrade for pavements. Where the crushed bedrock is open graded, a blinding layer of finer granular fill and/or a woven geotextile may be required to prevent adjacent finer materials from migrating into the voids, with associated loss of ground and settlements. This can be assessed at the time of construction. Site-generated crushed rock fill should be compacted using a suitably sized smooth drum vibratory roller when considered for placement.

Bedrock Removal

Bedrock removal can be accomplished by hoe ramming where the bedrock is weathered and/or where only small quantities of the bedrock need to be removed. Sound bedrock may be removed by line drilling in conjunction with controlled blasting and/or hoe ramming.

Prior to considering blasting operations, the blasting effects on the existing services, buildings, and other structures should be addressed. A pre-blast or pre-construction survey of the existing structures located in the proximity of the blasting operations should be carried out prior to commencing site activities.

The extent of the survey should be determined by the blasting consultant and should be sufficient to respond to any inquiries or claims related to the blasting operations.

As a general guideline, peak particle velocities (measured at the structures) should not exceed 25 mm/s during the blasting program to reduce the risks of damage to the existing surrounding structures. The blasting operations should be planned and conducted under the supervision of a licensed professional engineer who is also an experienced blasting consultant.

Vibration Considerations

Construction operations could cause vibrations, and possibly, sources of nuisance to the community. Therefore, means to reduce the vibration levels as much as possible should be incorporated in the construction operations to maintain a cooperative environment.

The following construction equipment could be a source of vibrations: rock drills, hoe ram, compactor, hydraulic shovel and excavators, dozer, crane, truck traffic, etc. Vibrations, whether it is caused by blasting operations or by construction operations, could be the cause of the source of detrimental vibrations on the nearby buildings and structures. Therefore, it is recommended that all vibrations be limited.

Two parameters determine the recommended vibration limit: the maximum peak particle velocity and the frequency. For low frequency vibrations, the maximum allowable peak particle velocity is less than that for high frequency vibrations. As a guideline, the peak particle velocity should be less than 15 mm/s between frequencies of 4 to 12 Hz, and 50 mm/s above a frequency of 40 Hz (interpolate between 12 and 40).

These guidelines are for current construction standards. Considering that these guidelines are above perceptible human level and, in some cases, could be very disturbing to some people, it is recommended that a pre-construction survey be completed to minimize the risks of claims during or following the construction of the proposed development.

5.3 Foundation Design

Bearing Resistance Values – Conventional Spread Footings

As noted above, based on the subsurface profile encountered in the test holes, it is recommended that the proposed buildings be founded on conventional spread footings placed on undisturbed compact glacial till, or clean, surface sounded bedrock.

Overburden Bearing Surface

Conventional spread footings placed on an undisturbed, compact glacial till bearing surface can be designed using a bearing resistance value at serviceability limit states (SLS) of **200 kPa** and a factored bearing resistance value at ultimate limit states (ULS) of **300 kPa** incorporating a geotechnical resistance factor of 0.5 at SLS.

An undisturbed glacial till bearing surface consists of one from which all topsoil and deleterious materials, such as loose, frozen, or disturbed soil, whether in-situ or not, have been removed, in the dry, prior to placement of concrete footings.

Bedrock Bearing Surface

Footings placed on clean, surface sounded bedrock can be designed using a factored bearing resistance value at ultimate limit states (ULS) of **1,000 kPa**, incorporating a geotechnical resistance factor of 0.5.

A clean, surface-sounded bedrock bearing surface should be free of loose materials and have no near surface seams, voids, fissures, or open joints which can be detected from surface sounding with a rock hammer.

Bearing resistance values for footing design should be confirmed on a per lot basis by the geotechnical consultant at the time of construction.

Bedrock/Soil Transition

Where a building is founded partly on bedrock and partly on soil, it is recommended to decrease the soil bearing resistance value by 25% for the footings placed on a soil bearing medium to reduce the potential for long-term total and differential settlements.

At the soil/bedrock transitions, it is recommended that a minimum depth of 300 mm of bedrock be removed from below the founding elevation for a minimum length of 2.0 m on the bedrock side. This area should be subsequently reinstated with an engineered fill, such as OPSS Granular A or OPSS Granular B Type II crushed stone and compacted to a minimum of 98% of the materials SPMDD. The width of the sub-excavation should be at least the proposed footing width plus 0.5 m. Steel reinforcement, extending at least 3 m on both sides of the 2 m long transition, should be placed in the top part of the footings and foundation walls.

Lateral Support

The bearing medium under footing-supported structures is required to be provided with adequate lateral support with respect to excavations and different foundation levels.

Adequate lateral support is provided to the in-situ bearing medium soils when a plane extending down and out from the bottom edges of the footing, at a minimum of 1.5H:1V, passes only through in situ soil of the same or higher capacity as that of the bearing medium.

Adequate lateral support is provided to sound bedrock bearing medium when a plane extending down and out from the bottom edges of the footing at a minimum of 1H:6V (or flatter) passes only through sound bedrock or a material of the same or higher capacity as the bedrock, such as concrete. A weathered bedrock bearing medium will require a lateral support zone of 1H:1V (or flatter).

Settlement

Footings placed on an undisturbed soil bearing surface and designed using the above noted bearing resistance values at SLS will be subject to potential post-construction total and differential settlements of 25 to 20 mm, respectively.

Footings bearing on an acceptable bedrock bearing surface and designed for the bearing resistance values provided above will be subjected to negligible potential post-construction total and differential settlements.

5.4 Design for Earthquakes

The site class for seismic site response can be taken as **Class C** for foundations constructed at the subject site as deduced from Table 4.1.8.4.A of the 2012 Ontario Building Code (OBC 2012). If a higher seismic site class is required (Class A or B), a site-specific shear wave velocity test may be completed to accurately determine the applicable seismic site classification for foundation design of the proposed buildings.

The soils underlying the subject site are not susceptible to liquefaction. Reference should be made to the latest revision of the 2012 Ontario Building Code for a full discussion of the earthquake design requirements.

5.5 Basement Slab/ Slab-on-Grade Construction

With the removal of all topsoil, peat, and fill containing significant amounts of deleterious or organic materials, the existing native soil or bedrock approved by the geotechnical consultant at the time of excavation will be considered an acceptable subgrade surface on which to commence backfilling for support of the floor slab.

For structures with basement slabs, it is recommended that the upper 200 mm of subfloor fill for the basement floor slab consists of 19 mm clear crushed stone. For any structure with slab-on-grade construction, the upper 200 mm of sub-slab fill is recommended to consist of OPSS Granular A crushed stone.

Any poor performing areas should be sub-excavated and reinstated using OPSS Granular B Type II. All backfill material within the footprint of the proposed building should consist of OPSS Granular B Type II and should be placed in maximum 300 mm thick loose layers and compacted to at least 98% of its SPMDD.

5.6 Basement Wall

There are several combinations of backfill materials and retained soils that could be applicable for the basement walls of the proposed basement space. However, the conditions can be well-represented by assuming the retained soil consists of a material with an angle of internal friction of 30 degrees and a bulk (drained) unit weight of 20 kN/m³.

Two distinct conditions, static and seismic, must be reviewed for design calculations. The parameters for design calculations for the two conditions are presented below.

Static Earth Pressures

The static horizontal earth pressure (p_o) can be calculated using a triangular earth pressure distribution equal to $K_o \cdot \gamma \cdot H$ where:

- K_o = at-rest earth pressure coefficient of the applicable retained material
- γ = unit weight of fill of the applicable retained soil (kN/m³)
- H = height of the wall (m)

An additional pressure having a magnitude equal to $K_o \cdot q$ and acting on the entire height of the wall should be added to the above diagram for any surcharge loading, q (kPa), that may be placed at ground surface adjacent to the wall. The surcharge pressure will only be applicable for static analyses and should not be used in conjunction with the seismic loading case.

Actual earth pressures could be higher than the “at-rest” case if care is not exercised during the compaction of the backfill materials to maintain a minimum separation of 0.3 m from the walls with the compaction equipment.

Seismic Earth Pressures

The total seismic force (P_{AE}) includes both the earth force component (P_o) and the seismic component (ΔP_{AE}). The seismic earth force (ΔP_{AE}) can be calculated using $0.375 \cdot a_c \cdot \gamma \cdot H^2/g$ where:

$$a_c = (1.45 - a_{max}/g)a_{max}$$

γ = unit weight of fill of the applicable retained soil (kN/m³)

H = height of the wall (m)

g = gravity, 9.81 m/s²

The peak ground acceleration, (a_{max}), for the Ottawa area is 0.22g according to OBC 2012. Note that the vertical seismic coefficient is assumed to be zero.

The earth force component (P_o) under seismic conditions can be calculated using $P_o = 0.5 K_o \gamma H^2$, where $K_o = 0.5$ for the soil conditions noted above.

The total earth force (P_{AE}) is considered to act at a height, h (m), from the base of the wall, where:

$$h = \{P_o \cdot (H/3) + \Delta P_{AE} \cdot (0.6 \cdot H)\} / P_{AE}$$

The earth forces calculated are unfactored. For the ULS case, the earth loads should be factored as live loads, as per OBC 2012.

5.7 Pavement Design

The following design tables may be considered for the design driveways, car-parking areas and local residential roadways throughout the subject site.

Table 2 – Recommended Pavement Structure – Driveways and Car-Only Parking Areas	
Thickness (mm)	Material Description
50	Wear Course – HL-3 or Superpave 12.5 Asphaltic Concrete
150	BASE – OPSS Granular A Crushed Stone
300	SUBBASE – OPSS Granular B Type II Crushed Stone
SUBGRADE – Either fill, in-situ soil, or OPSS Granular B Type I or II material placed over in-situ soil.	

Table 3 – Recommended Pavement Structure – Local Residential Roadways	
Thickness (mm)	Material Description
40	Wear Course – HL-3 or Superpave 12.5 Asphaltic Concrete
50	Binder Course – HL-8 or Superpave 19.0 Asphaltic Concrete
150	BASE – OPSS Granular A Crushed Stone
450	SUBBASE – OPSS Granular B Type II Crushed Stone
SUBGRADE – Either fill, in-situ soil, or OPSS Granular B Type I or II material placed over in-situ soil.	

Minimum Performance Graded (PG) 58-34 asphalt cement should be used for this project.

The pavement granular base and subbase should be placed in maximum 300 mm thick lifts and compacted to a minimum of 100% of the material's SPMDD using suitable vibratory equipment.

If bedrock is encountered at the subgrade level, the total thickness of the pavement granular materials (base and subbase) could be reduced to 300 mm. The upper 300 mm of the bedrock surface should be reviewed and approved by Paterson prior to placing the base and subbase materials. Care should be exercised to ensure that the bedrock subgrade does not have depressions that will trap the water.

Subgrades for walkways against the building should be sloped to divert water towards the buildings foundation drainage system.

6.0 Design and Construction Precautions

6.1 Foundation Drainage and Backfill

Foundation Drainage

If basement units are considered for the future homes, a perimeter foundation drainage system should be provided for the proposed structures. The system should consist of a 150 mm diameter perforated and corrugated plastic pipe, surrounded on all sides by 150 mm of 19 mm clear crushed stone, which is placed at the footing level around the exterior perimeter of the basement walls. The pipe should have a positive outlet, such as a gravity connection to the storm sewer or to a sump pit.

Foundation Backfill

Backfill against the exterior sides of the basement walls should consist of free-draining, non-frost susceptible granular materials. The greater part of the site excavated materials will be frost susceptible and, as such, are not recommended for placement as backfill against the foundation walls unless used in conjunction with a composite drainage system, such as Delta Drain 6000 or Miradrain G100N. Imported granular materials, such as clean sand or OPSS Granular B Type I granular material, should be placed for this purpose.

6.2 Protection of Footings Against Frost Action

Perimeter footings of heated structures are required to be insulated against the deleterious effect of frost action. A minimum of 1.5 m thick soil cover, or an equivalent thickness of soil cover and insulation, should be provided in this regard.

Exterior unheated footings, such as those for isolated exterior piers for decks, are more prone to deleterious movement associated with frost action and require additional protection, such as soil cover of 2.1 m, or an equivalent combination of soil cover and foundation insulation.

However, sound bedrock bearing mediums are not considered as frost susceptible, such that footings placed directly on sound bedrock would not require the minimum soil cover, as referenced above, to mitigate the migration of frost.

6.3 Excavation Side Slopes

The side slopes of shallow excavations anticipated at this site should either be cut back at acceptable slopes or be retained by temporary shoring systems from the start of the excavation until the structure is backfilled.

It is assumed that sufficient room will be available for the greater part of the excavation to be undertaken by open-cut methods (i.e. unsupported excavations).

Unsupported Excavations

The excavation side slopes above the groundwater level extending to a maximum depth of 3 m should be cut back at 1H:1V or flatter. The flatter slope is required for excavation below groundwater level. The subsoil at this site is considered to be mainly a Type 2 and 3 soil according to the Occupational Health and Safety Act and Regulations for Construction Projects.

Excavated soil should not be stockpiled directly at the top of excavations and heavy equipment should be kept away from the excavation sides.

Slopes in excess of 3 m in height should be periodically inspected by the geotechnical consultant in order to detect if the slopes are exhibiting signs of distress.

Excavation side slopes around the building excavation should be protected from erosion by surface water and rainfall events and drying during drier weather by the use of secured tarpaulins spanning the length of the side slopes, or other means of erosion protection along their footprint. Efforts should also be made to maintain dry surfaces at the bottom of the excavation footprints and along the bottom of side slopes to prevent disturbance to the toe of the slope. Additional measures may be recommended at the time of construction by the geotechnical consultant.

It is recommended that a trench box be used at all times to protect personnel working in trenches with steep or vertical sides. It is expected that services will be installed by “cut and cover” methods and excavations will not be left open for extended periods of time.

6.4 Pipe Bedding and Backfill

At least 150 mm of OPSS Granular A should be used for pipe bedding for sewer and water pipes when placed on soil subgrade. Should bedrock be encountered at the bedding level, the bedding layer should be increased to a minimum thickness of 300 mm.

The material should be placed in maximum 300 mm thick lifts and compacted to a minimum of 95% of its SPMDD. The bedding should extend to the spring line of the pipe.

Cover material from the spring line to at least 300 mm above the obvert of the pipe should consist of OPSS Granular A or Granular B Type II with a maximum size of 25 mm. The bedding and cover materials should be placed in maximum 225 mm thick lifts compacted to 95% of the material's standard Proctor maximum dry density.

Where hard surface areas are considered above the trench backfill, the trench backfill material within the frost zone (about 1.8 m below finish grade) should match the soils exposed at the trench walls to reduce the potential differential frost heaving. The trench backfill should be placed in maximum 300 mm thick loose lifts and compacted to a minimum of 95% of the material's SPMDD. All cobbles larger than 200 mm in their longest direction should be segregated from re-use as trench backfill.

6.5 Groundwater Control

Groundwater Control for Building Construction

Based on our observations, it is anticipated that groundwater infiltration into the excavations should be low and controllable using open sumps. The contractor should be prepared to direct water away from all bearing surfaces and subgrades, regardless of the source, to prevent disturbance to the founding medium.

Permit to Take Water

A temporary Ministry of Environment, Conservation and Parks (MECP) permit to take water (PTTW) may be required if more than 400,000 L/day of ground and/or surface water are to be pumped during the construction phase. At least 4 to 5 months should be allowed for completion of the application and issuance of the permit by the MECP.

For typical ground or surface water volumes being pumped during the construction phase, typically between 50,000 to 400,000 L/day, it is required to register on the Environmental Activity and Sector Registry (EASR). A minimum of two to four weeks should be allotted for completion of the EASR registration and the Water Taking and Discharge Plan to be prepared by a Qualified Person as stipulated under O.Reg. 63/16. If a project qualifies for a PTTW based upon anticipated conditions, an EASR will not be allowed as a temporary dewatering measure while awaiting the MECP review of the PTTW application.

6.6 Winter Construction

Precautions must be taken if winter construction is considered for this project.

The subsoil conditions at this site consist of frost susceptible materials. In the presence of water and freezing conditions, ice could form within the soil mass. Heaving and settlement upon thawing could occur.

In the event of construction during below zero temperatures, the founding stratum should be protected from freezing temperatures by the use of straw, propane heaters and tarpaulins or other suitable means. In this regard, the base of the excavations should be insulated from sub-zero temperatures immediately upon exposure and until such time as heat is adequately supplied to the building and the footings are protected with sufficient soil cover to prevent freezing at founding level.

Trench excavations and pavement construction are also difficult activities to complete during freezing conditions without introducing frost in the subgrade or in the excavation walls and bottoms. Precautions should be taken if such activities are to be carried out during freezing conditions. Additional information could be provided, if required.

6.7 Corrosion Potential and Sulphate

The results of analytical testing show that the sulphate content is less than 0.1%. This result is indicative that Type 10 Portland cement (normal cement) would be appropriate for this site. The chloride content and the pH of the sample indicate that they are not significant factors in creating a corrosive environment for exposed ferrous metals at this site, whereas the resistivity is indicative of a low to slightly aggressive corrosive environment.

7.0 Recommendations

It is a requirement for the foundation design data provided herein to be applicable that the following material testing and observation program be performed by the geotechnical consultant.

- Observation of all bearing surfaces prior to the placement of concrete.
- Sampling and testing of the concrete and fill materials.
- Periodic observation of the condition of unsupported excavation side slopes in excess of 3 m in height, if applicable.
- Review of the installation of the foundation drainage system.
- Observation of all subgrades prior to backfilling.
- Field density tests to determine the level of compaction achieved.
- Sampling and testing of the bituminous concrete including mix design reviews.

A report confirming that these works have been conducted in general accordance with our recommendations could be issued upon the completion of a satisfactory inspection program by the geotechnical consultant.

All excess soil must be handled as per *Ontario Regulation 406/19: On-Site and Excess Soil Management*.

8.0 Statement of Limitations

The recommendations provided are in accordance with the present understanding of the project. Paterson requests permission to review the recommendations when the drawings and specifications are completed.

A soils investigation is a limited sampling of a site. Should any conditions at the site be encountered which differ from those at the test locations, Paterson requests immediate notification to permit reassessment of our recommendations.

The recommendations provided herein should only be used by the design professionals associated with this project. They are not intended for contractors bidding on or undertaking the work. The latter should evaluate the factual information provided in this report and determine the suitability and completeness for their intended construction schedule and methods. Additional testing may be required for their purposes.

The present report applies only to the project described in this document. Use of this report for purposes other than those described herein or by person(s) other than 13165647 Canada Inc. or their agents is not authorized without review by Paterson for the applicability of our recommendations to the alternative use of the report.

Paterson Group Inc.



Drew Petahtegoose, B. Eng.



David J. Gilbert, P.Eng.

Report Distribution:

- 13165647 Canada Inc. (Digital copy)
- Paterson Group (1 copy)

APPENDIX - C

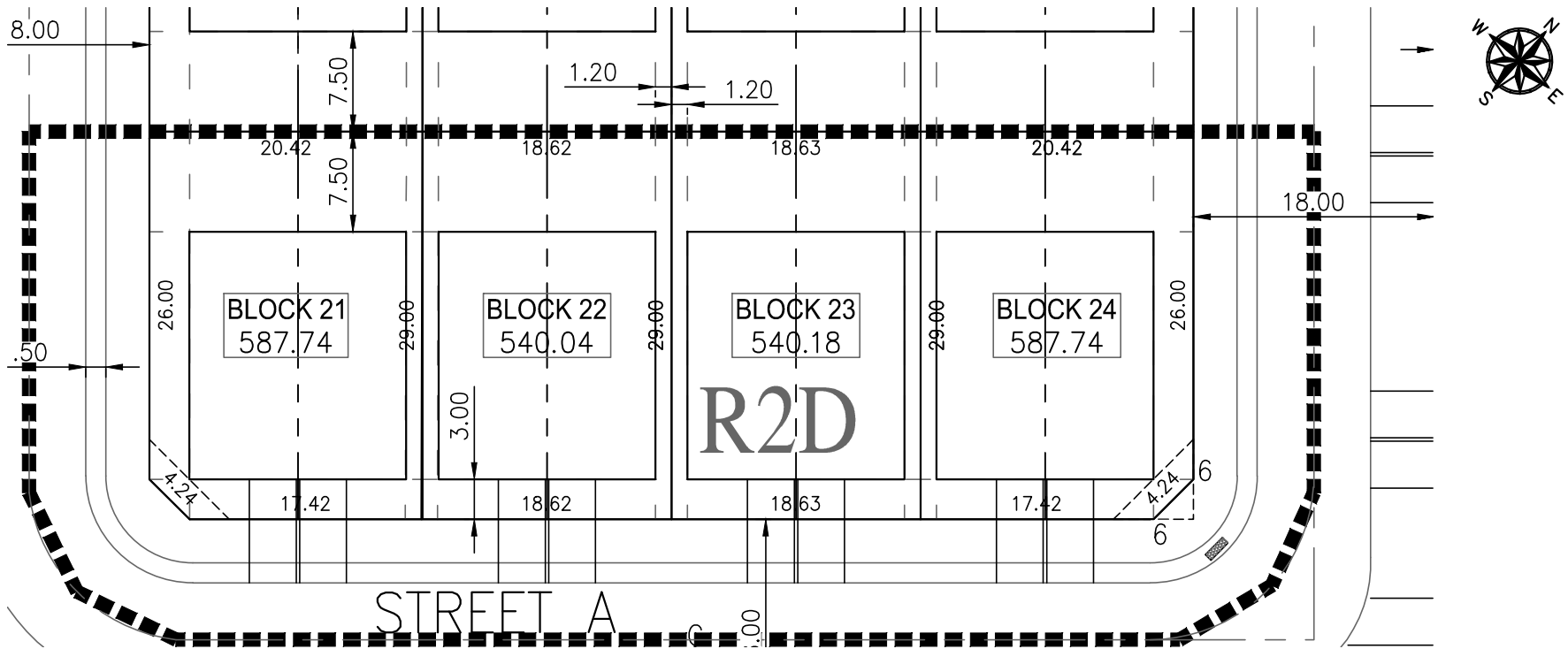

TOTAL DRAINAGE AREA = 3574.4 m²
 TOTAL AREA OF THE 4 BLOCKS = 2256 m²
 TOTAL AREA OF THE 4 ROOFS (MAX OF 30%) = 0.30 x 2256 = 677 m²
 TOTAL AREA OF THE 8 DRIVEWAYS = 8 x 7.75 x 3.50 = 217 m²
 AREA OF STREET PAVEMENT = 155.3 x 4.25 = 660 m²
 AREA OF SIDEWALK = 147.8 x 1.5 = 222 m²

NOTES

* DISTANCES ARE IN METRE

WEIGHTED RUNOFF COEFFICIENT
AND IMPERVIOUSNESS RATIO (1:500)

WEIGHTED RUNOFF COEFFICIENT			
IMPERVIOUS SURFACE		AREA (m ²)	RUNOFF COEF.
1	ROOF AREAS	677	0.9
2	DRIVEWAYS	217	0.9
3	PAVED ROAD	660	0.9
4	SIDEWALK (1.5 m)	222	0.9
TOTAL IMPERVIOUS AREA		1776	
TOTAL CATCHMENT AREA		3574.4	
TOTAL PERVIOUS AREA		1798	0.25
WEIGHTED RUNOFF COEFFICIENT		0.57	
IMPERVIOUSNESS RATIO		0.50	

RUNOFF CALCULATIONS – RATIONAL METHOD

$$Q_{2,5,25,100\text{-yr}} = 2.78 C I_{2,5,25,100\text{-yr}} A$$

where:

A : Area in ha

I : Peak Rainfall Intensity in mm / hr

C : Runoff Coefficient

Rainfall Intensity I (mm/hr) Pre-Dev. Post-Dev.

Tc (min) =	15	13
2 year I ₂ =	61.77	66.93
5 year I ₅ =	83.56	90.63
25 year I ₂₅ =	115.83	115.83
100 year I ₁₀₀ =	142.89	155.11

Runoff Coefficient C

Surface Type	C*
Impervious: Rooftop-Asphalt Pavement-Driveway	0.9
Road Shoulders	0.7
Grass-Cultivated-Pasture	0.2-0.5
Woodland	0.25-0.5

* Add 25% and 10% to C value when calculating Q_{100-yr} and Q_{25-yr} respectively.

* Table 5.7 *Ottawa Sewer Design Guidelines – October 2012*

I/ PRE-DEVELOPMENT RUNOFF CALCULATION										
Catchment	ID	Area (ha)	Percent of Total Area	C		A x C (ha)	C relative	Q 2-year (L/s)	Q 5-year (L/s)	Q 100-year (L/s)
				2-5 y	100 y					
Trees / Grass	A1	2.0689	72.78	0.25	0.31	0.5172	0.18	88.8	120.1	256.8
Trees / Grass	A2	0.7737	27.22	0.25	0.31	0.1934	0.07	33.2	44.9	96.0
TOTAL (Buffer incl.)		2.8426	100%			0.7107		122	165	353
All Site – Buffer	At	2.6904		0.25	0.31	0.6726	0.24	115	156	334

II/ POST-DEVELOPMENT RUNOFF CALCULATION – BUFFER ZONE INCLUDED												
Catchment	ID	Area (ha)	Percent of Total Area (%)	C		A x C (ha)	C relative	Q 2-year (L/s)	Q 5-year (L/s)	Q 100-year (L/s)	Q _{100y} by Control Measure (L/s)	
				2-5 y	100 y						CONT.	UNC.
All site (-) STM (-) Buffer	A1	2.5576	89.97	0.57	0.62	1.4578	0.513	271.3	367.3	684	684	
STM Facility	A2	0.1328	4.67	0.25	0.31	0.0332	0.012	6.2	8.4	18	18	
Buffer Zone	A3	0.1522	5.35	0.25	0.31	0.0381	0.013	7.1	9.6	20		20
TOTAL		2.8426	100%			1.5291		285	385	722	702	20

III/ POST-DEVELOPMENT RUNOFF CALCULATION – BUFFER ZONE NOT INCLUDED												
Catchment	ID	Area (ha)	Percent of Total Area (%)	C		A x C (ha)	C relative	Q 2-year (L/s)	Q 5-year (L/s)	Q 100-year (L/s)	Q _{100y} by Control Measure (L/s)	
				2-5 y	100 y						CONT.	UNC.
All site (-) STM (-) Buffer	A1	2.5576	95.06	0.57	0.62	1.4578	0.542	271.3	367.3	684	684	
STM Facility	A2	0.1328	4.94	0.25	0.31	0.0332	0.012	6.2	8.4	18	18	
TOTAL		2.6904	100%			1.4910	0.55*	277	376	702	702	0

* C_{weighted} for 100y event = 0.60

ON-SITE RUNOFF STORAGE CALCULATION – MODIFIED RATIONAL METHOD

I- REQUIRED STORAGE

100y-event

C_{avg} = 0.60 blended
 Area= 2.6904 ha
 Release Rate= 334 L/s
 Storm Event Frequency= 100 year
 Time Interval= 10 min

Area (ha)	Runoff Coeff. (Avg)	2.78 C A (ha)	Duration (min)	Rainfall Intensity (mm/hr)	Peak Flow (m ³ /s)	Release Rate (m ³ /s)	Storage Rate (m ³ /s)	Storage Volume (m ³)
2.6904	0.60	4.49	2	315.00	1.414	0.334	1.080	129.55
2.6904	0.60	4.49	4	262.41	1.178	0.334	0.844	202.46
2.6904	0.60	4.49	6	226.01	1.014	0.334	0.680	244.89
2.6904	0.60	4.49	8	199.20	0.894	0.334	0.560	268.77
2.6904	0.60	4.49	10	178.56	0.801	0.334	0.467	280.38
2.6904	0.60	4.49	12	162.13	0.728	0.334	0.394	283.38 *
2.6904	0.60	4.49	14	148.72	0.667	0.334	0.333	280.06
2.6904	0.60	4.49	16	137.55	0.617	0.334	0.283	271.93
2.6904	0.60	4.49	18	128.08	0.575	0.334	0.241	260.05
2.6904	0.60	4.49	20	119.95	0.538	0.334	0.204	245.15
2.6904	0.60	4.49	22	112.88	0.507	0.334	0.173	227.79
2.6904	0.60	4.49	24	106.68	0.479	0.334	0.145	208.39

5y-event

C_{avg} = 0.55 blended
 Area= 2.6904 ha
 Release Rate= 156 L/s
 Storm Event Frequency= 5 year
 Time Interval= 10 min

Area (ha)	Runoff Coeff. (Avg)	2.78 C A (ha)	Duration (min)	Rainfall Intensity (mm/hr)	Peak Flow (m ³ /s)	Release Rate (m ³ /s)	Storage Rate (m ³ /s)	Storage Volume (m ³)
2.6904	0.55	4.11	2	182.69	0.752	0.156	0.596	71.46
2.6904	0.55	4.11	4	152.51	0.627	0.156	0.471	113.13
2.6904	0.55	4.11	6	131.57	0.541	0.156	0.385	138.68
2.6904	0.55	4.11	8	116.11	0.478	0.156	0.322	154.39
2.6904	0.55	4.11	10	104.19	0.429	0.156	0.273	163.57
2.6904	0.55	4.11	12	94.70	0.390	0.156	0.234	168.15
2.6904	0.55	4.11	14	86.93	0.358	0.156	0.202	169.35 *
2.6904	0.55	4.11	16	80.46	0.331	0.156	0.175	167.98
2.6904	0.55	4.11	18	74.97	0.308	0.156	0.152	164.59
2.6904	0.55	4.11	20	70.25	0.289	0.156	0.133	159.58
2.6904	0.55	4.11	22	66.15	0.272	0.156	0.116	153.25

**Menzie Enclaves Subdivision – Stormwater
Dry Pond Storage Stages**

Contour Elevation	Contour Area (sq.m)	Depth (Head) (m)	Incremental Volume (cu.m)	Incremental Volume (cu.m)
105.825	334.67	N/A	N/A	0
105.900	346.08	0.075	25.53	25.53
105.975	357.78	0.075	26.39	51.92
106.050	369.63	0.075	27.28	79.20
106.125	381.60	0.075	28.17	107.37
106.200	393.69	0.075	29.07	136.44
106.275	405.91	0.075	29.98	166.42
106.350	418.27	0.075	30.91	197.33
106.425	430.77	0.075	31.84	229.17
106.500	443.70	0.075	32.79	261.96
106.575	462.67	0.075	33.99	295.94
106.650	482.30	0.075	35.43	331.38
106.725	502.24	0.075	36.92	368.30
106.800	522.51	0.075	38.43	406.72
106.875	543.09	0.075	39.96	446.68
106.950	563.98	0.075	41.51	488.19
107.025	585.18	0.075	43.09	531.28
107.100	606.69	0.075	44.69	575.98
107.175	628.50	0.075	46.32	622.29
107.250	650.64	0.075	47.97	670.26
107.325	673.09	0.075	49.64	719.90
107.400	695.86	0.075	51.33	771.23
107.475	719.17	0.075	53.06	824.29

MENZIE ENCLAVES - STORMWATER MANAGEMENT

Pre-Development

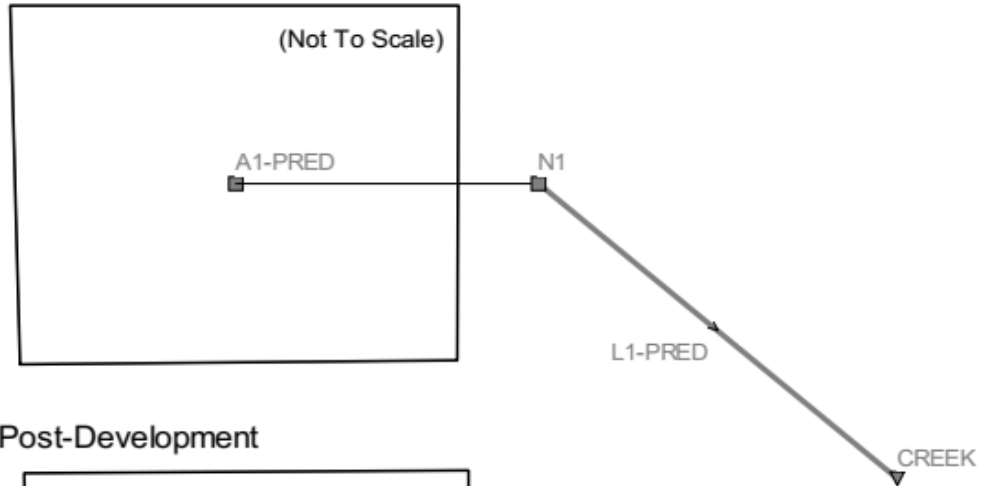

Post-Development

RainGage

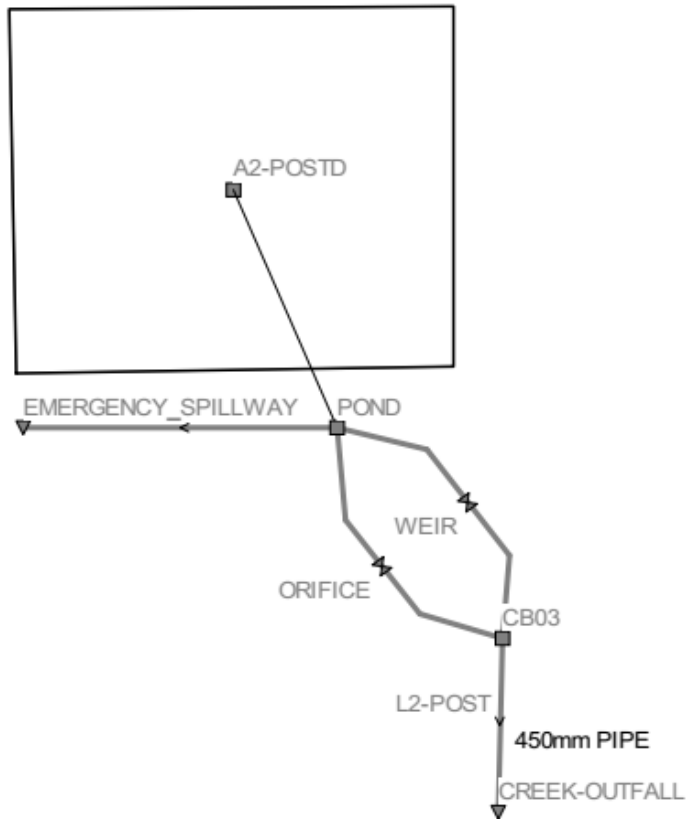

CHICAGO STORM 100Y 4 HRS

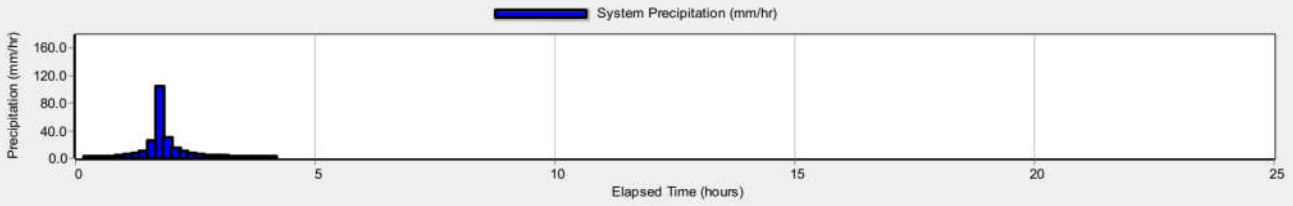

Subcatchment Runoff Summary

Subcatchment	Total Precip mm	Total Runon mm	Total Evap mm	Total Infil mm	Imperv Runoff mm	Perv Runoff mm	Total Runoff mm	Total Runoff 10 ⁶ ltr	Peak Runoff LPS	Runoff Coeff
A1-PRED	45.18	0.00	0.00	41.60	0.00	3.58	3.58	0.10	56.47	0.079
A2-POSTD	45.18	0.00	0.00	20.54	22.01	2.05	24.06	0.65	417.99	0.533

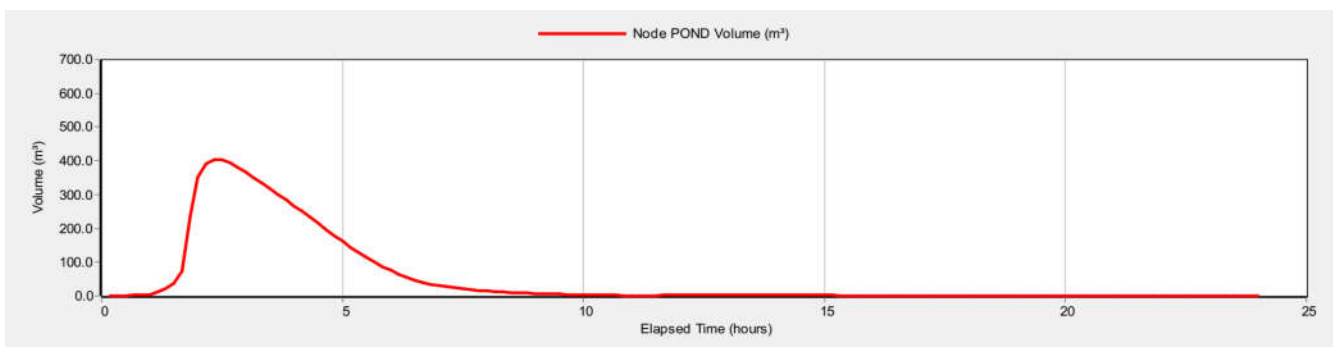
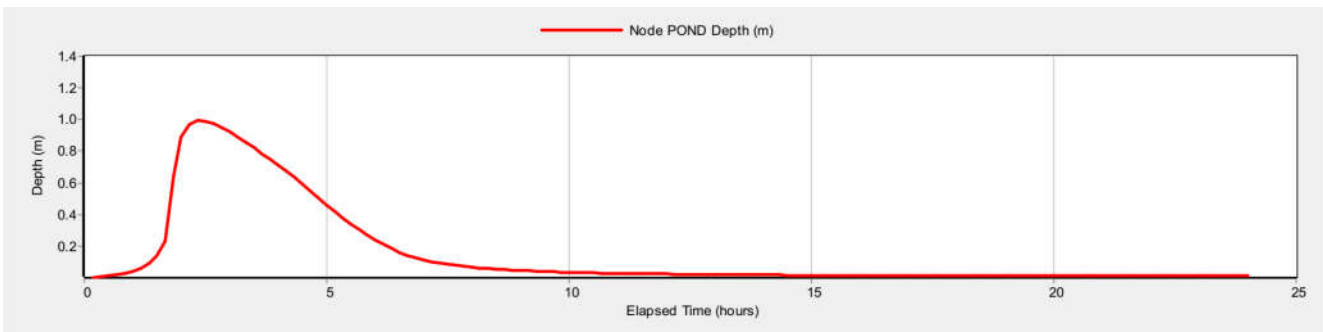
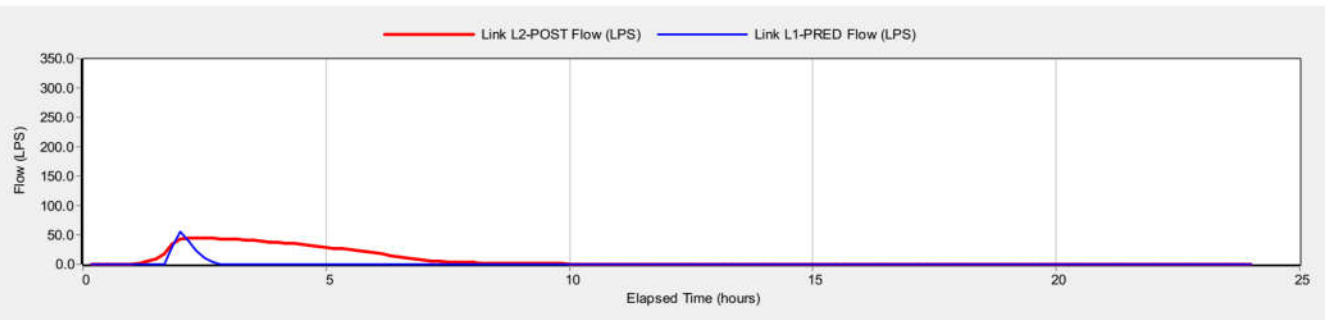

CHICAGO STORM 100Y 4 HRS

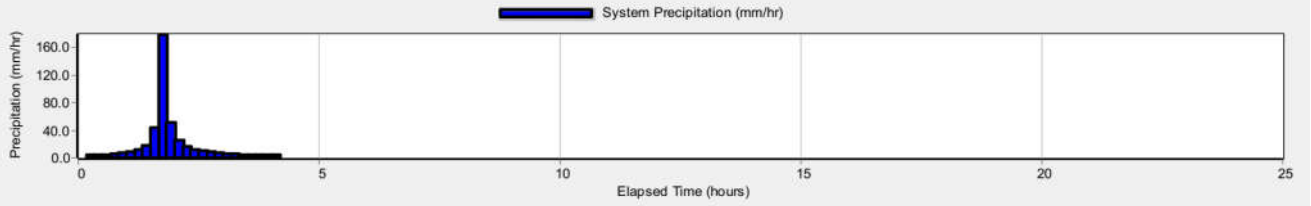

Subcatchment Runoff Summary

Subcatchment	Total Precip mm	Total Runon mm	Total Evap mm	Total Infil mm	Imperv Runoff mm	Perv Runoff mm	Total Runoff mm	Total Runoff 10 ⁶ ltr	Peak Runoff LPS	Runoff Coeff
A2-POSTD	76.02	0.00	0.00	25.03	37.44	12.99	50.44	1.36	874.96	0.663
A1-PRED	76.02	0.00	0.00	51.14	0.00	24.89	24.89	0.67	341.68	0.327

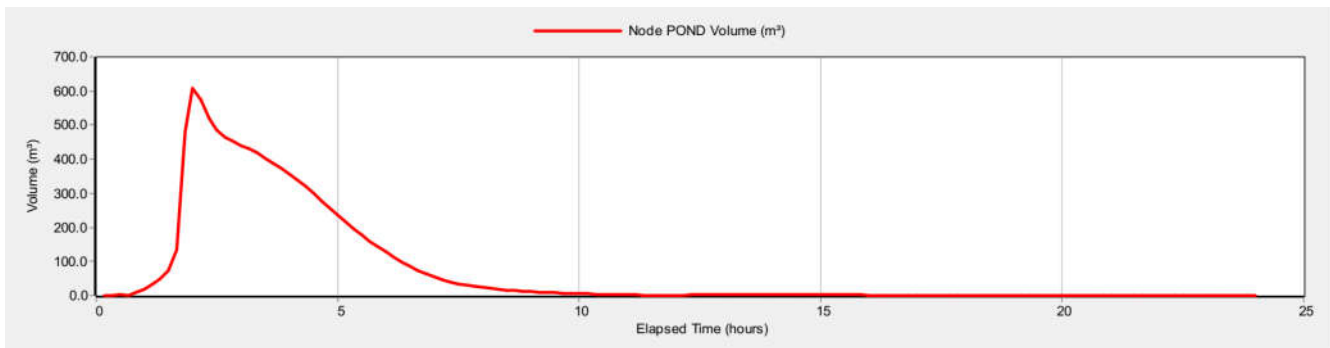
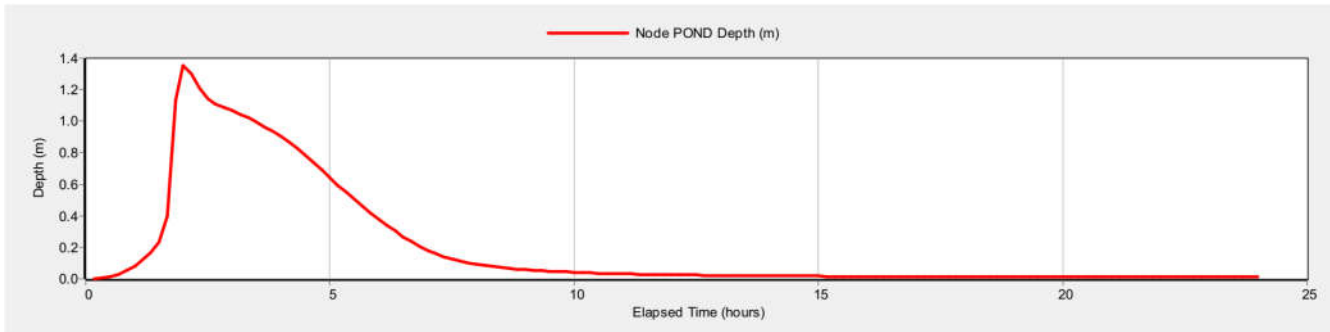
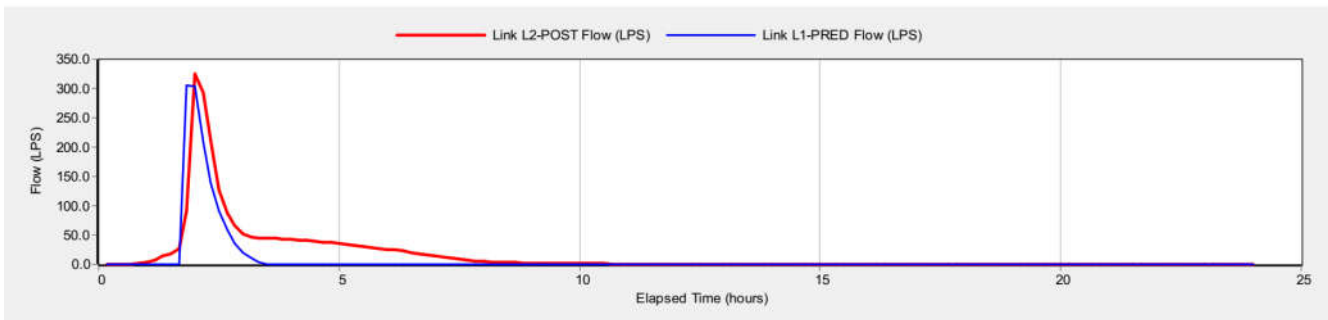

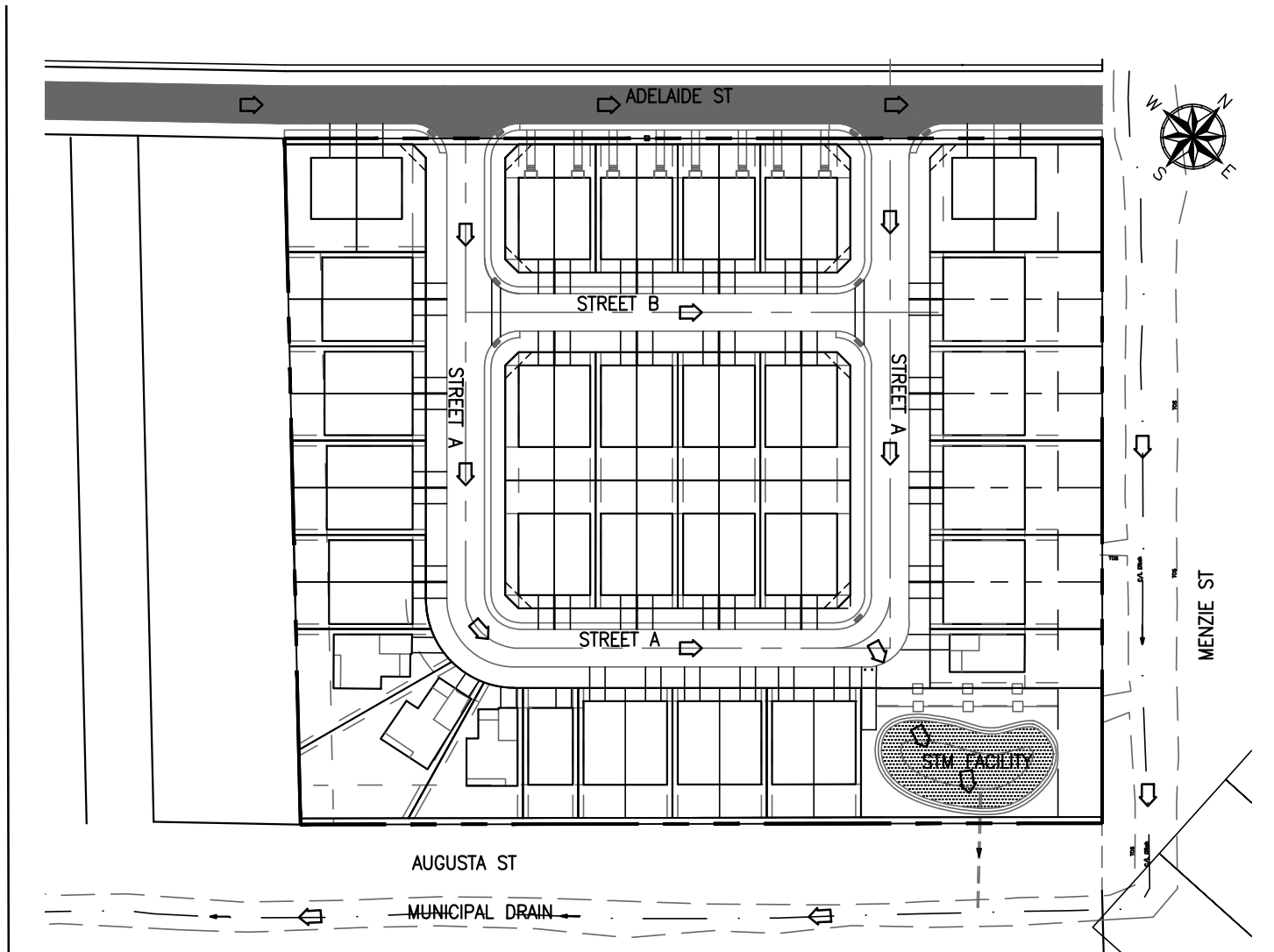

LEGEND

⇨ OVERLAND FLOW - MAJOR SYSTEM

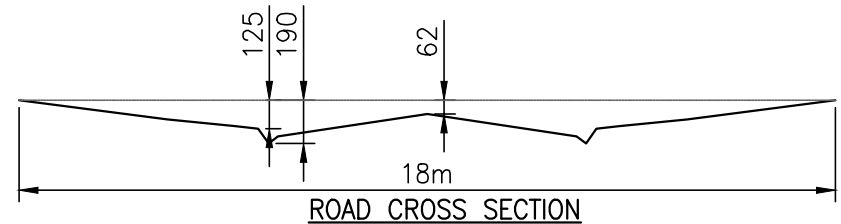

**PROPOSED SUBDIVISION
STORMWATER DESIGN - MAJOR SYSTEM RUNOFF ROUTE (SCALE: 1:2000)**

Stormceptor® EF Sizing Report

**STORMCEPTOR®
ESTIMATED NET ANNUAL SEDIMENT (TSS) LOAD REDUCTION**

01/21/2023

Province:	Ontario
City:	Mississippi Mills
Nearest Rainfall Station:	OTTAWA CDA RCS
Climate Station Id:	6105978
Years of Rainfall Data:	20

Project Name:	Menzie Subdivision - 2.69 ha
Project Number:	123
Designer Name:	M Mabrouk
Designer Company:	Engineer
Designer Email:	eng.services.ca@gmail.com
Designer Phone:	613-986-9170
EOR Name:	
EOR Company:	
EOR Email:	
EOR Phone:	

Site Name:	Menzie Subdivision
------------	--------------------

Drainage Area (ha):	2.690
% Imperviousness:	50.00

Runoff Coefficient 'c': 0.60

Particle Size Distribution:	Fine
Target TSS Removal (%):	80.0

Required Water Quality Runoff Volume Capture (%):	90.00
Estimated Water Quality Flow Rate (L/s):	52.09
Oil / Fuel Spill Risk Site?	Yes
Upstream Flow Control?	Yes
Upstream Orifice Control Flow Rate to Stormceptor (L/s):	156.00
Peak Conveyance (maximum) Flow Rate (L/s):	
Site Sediment Transport Rate (kg/ha/yr):	

Net Annual Sediment (TSS) Load Reduction Sizing Summary	
Stormceptor Model	TSS Removal Provided (%)
EFO4	63
EFO6	77
EFO8	85
EFO10	90
EFO12	95

Recommended Stormceptor EFO Model: EFO8
Estimated Net Annual Sediment (TSS) Load Reduction (%): 85
Water Quality Runoff Volume Capture (%): > 90



Stormceptor® EF Sizing Report

THIRD-PARTY TESTING AND VERIFICATION

► **Stormceptor® EF and Stormceptor® EFO** are the latest evolutions in the Stormceptor® oil-grit separator (OGS) technology series, and are designed to remove a wide variety of pollutants from stormwater and snowmelt runoff. These technologies have been third-party tested in accordance with the Canadian ETV **Procedure for Laboratory Testing of Oil-Grit Separators** and performance has been third-party verified in accordance with the **ISO 14034 Environmental Technology Verification (ETV)** protocol.

PERFORMANCE

► **Stormceptor® EF and EFO** remove stormwater pollutants through gravity separation and floatation, and feature a patent-pending design that generates positive removal of total suspended solids (TSS) throughout each storm event, including high-intensity storms. Captured pollutants include sediment, free oils, and sediment-bound pollutants such as nutrients, heavy metals, and petroleum hydrocarbons. Stormceptor is sized to remove a high level of TSS from the frequent rainfall events that contribute the vast majority of annual runoff volume and pollutant load. The technology incorporates an internal bypass to convey excessive stormwater flows from high-intensity storms through the device without resuspension and washout (scour) of previously captured pollutants. Proper routine maintenance ensures high pollutant removal performance and protection of downstream waterways.

PARTICLE SIZE DISTRIBUTION (PSD)

► The **Canadian ETV PSD** shown in the table below was used, or in part, for this sizing. This is the identical PSD that is referenced in the Canadian ETV **Procedure for Laboratory Testing of Oil-Grit Separators** for both sediment removal testing and scour testing. The Canadian ETV PSD contains a wide range of particle sizes in the sand and silt fractions, and is considered reasonably representative of the particle size fractions found in typical urban stormwater runoff.

Particle Size (µm)	Percent Less Than	Particle Size Fraction (µm)	Percent
1000	100	500-1000	5
500	95	250-500	5
250	90	150-250	15
150	75	100-150	15
100	60	75-100	10
75	50	50-75	5
50	45	20-50	10
20	35	8-20	15
8	20	5-8	10
5	10	2-5	5
2	5	<2	5

Stormceptor®EF Sizing Report

Upstream Flow Controlled Results

Rainfall Intensity (mm / hr)	Percent Rainfall Volume (%)	Cumulative Rainfall Volume (%)	Flow Rate (L/s)	Flow Rate (L/min)	Surface Loading Rate (L/min/m ²)	Removal Efficiency (%)	Incremental Removal (%)	Cumulative Removal (%)
0.5	8.6	8.6	2.24	135.0	29.0	100	8.6	8.6
1	20.3	29.0	4.49	269.0	57.0	100	20.3	29.0
2	16.2	45.2	8.97	538.0	115.0	95	15.3	44.3
3	12.0	57.2	13.46	808.0	172.0	87	10.4	54.7
4	8.4	65.6	17.95	1077.0	229.0	82	6.9	61.6
5	5.9	71.6	22.43	1346.0	286.0	79	4.7	66.4
6	4.6	76.2	26.92	1615.0	344.0	77	3.5	69.9
7	3.1	79.3	31.41	1885.0	401.0	74	2.3	72.2
8	2.7	82.0	35.90	2154.0	458.0	72	2.0	74.1
9	3.3	85.3	40.38	2423.0	516.0	69	2.3	76.4
10	2.3	87.6	44.87	2692.0	573.0	66	1.5	77.9
11	1.6	89.2	49.36	2961.0	630.0	64	1.0	78.9
12	1.3	90.5	53.84	3231.0	687.0	64	0.8	79.8
13	1.7	92.2	58.33	3500.0	745.0	64	1.1	80.9
14	1.2	93.5	62.82	3769.0	802.0	63	0.8	81.7
15	1.2	94.6	67.30	4038.0	859.0	63	0.7	82.4
16	0.7	95.3	71.79	4307.0	916.0	62	0.4	82.8
17	0.7	96.1	76.28	4577.0	974.0	62	0.5	83.3
18	0.4	96.5	80.76	4846.0	1031.0	61	0.2	83.5
19	0.4	96.9	85.25	5115.0	1088.0	60	0.2	83.8
20	0.2	97.1	89.74	5384.0	1146.0	58	0.1	83.9
21	0.5	97.5	94.23	5654.0	1203.0	57	0.3	84.1
22	0.2	97.8	98.71	5923.0	1260.0	56	0.1	84.3
23	1.0	98.8	103.20	6192.0	1317.0	54	0.5	84.8
24	0.3	99.1	107.69	6461.0	1375.0	53	0.1	85.0
25	0.0	99.1	112.17	6730.0	1432.0	51	0.0	85.0
30	0.9	100.0	134.61	8076.0	1718.0	43	0.4	85.4
35	0.0	100.0	156.00	9360.0	1991.0	37	0.0	85.4
40	0.0	100.0	156.00	9360.0	1991.0	37	0.0	85.4
45	0.0	100.0	156.00	9360.0	1991.0	37	0.0	85.4
Estimated Net Annual Sediment (TSS) Load Reduction =								85 %

Climate Station ID: 6105978 Years of Rainfall Data: 20



Stormceptor® EF Sizing Report

RAINFALL DATA FROM OTTAWA CDA RCS RAINFALL STATION

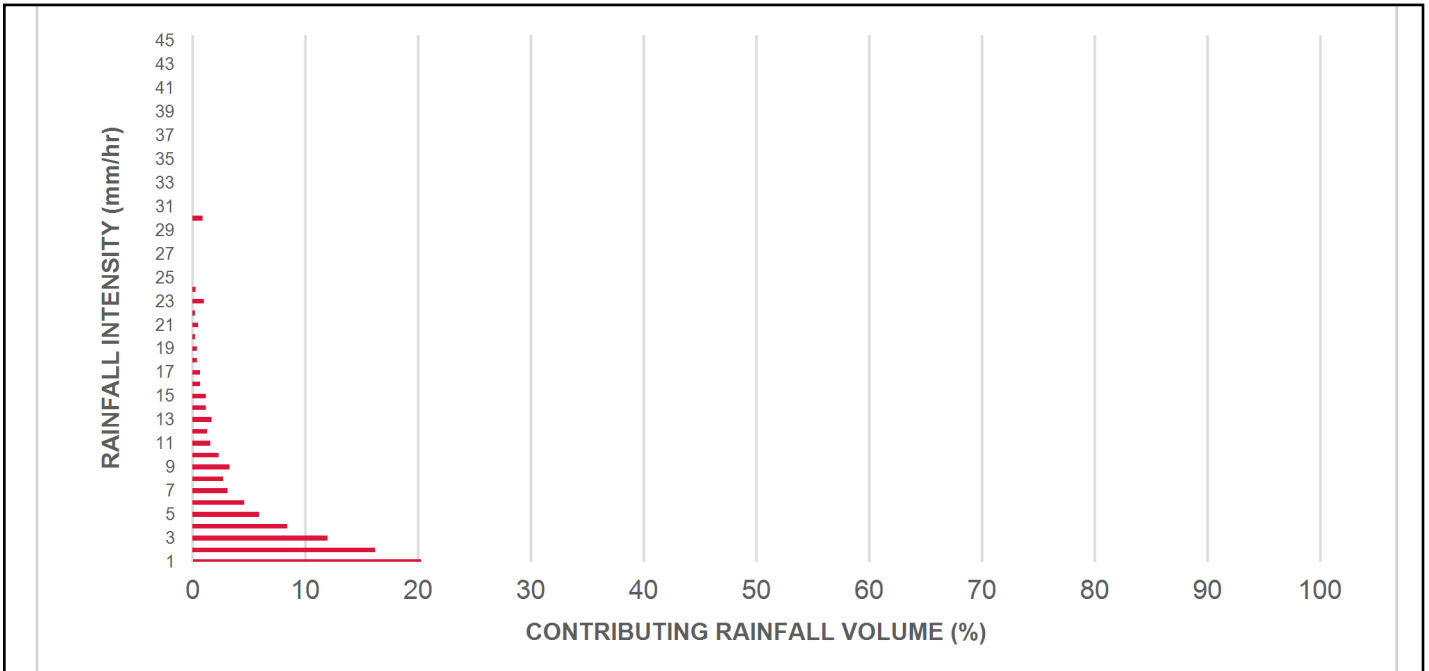

INCREMENTAL AND CUMULATIVE TSS REMOVAL FOR THE RECOMMENDED STORMCEPTOR® MODEL

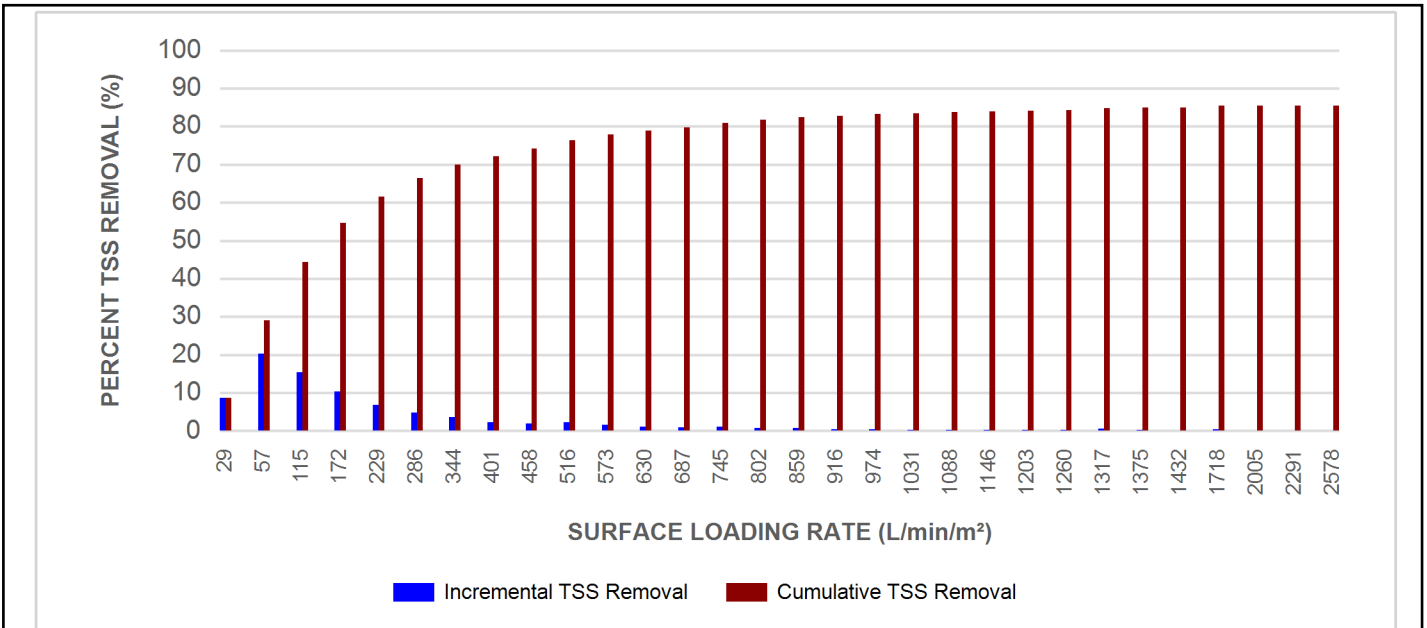

Stormceptor® **EF** Sizing Report

Maximum Pipe Diameter / Peak Conveyance

Stormceptor EF / EFO	Model Diameter		Min Angle Inlet / Outlet Pipes	Max Inlet Pipe Diameter		Max Outlet Pipe Diameter		Peak Conveyance Flow Rate	
	(m)	(ft)		(mm)	(in)	(mm)	(in)	(L/s)	(cfs)
EF4 / EFO4	1.2	4	90	609	24	609	24	425	15
EF6 / EFO6	1.8	6	90	914	36	914	36	990	35
EF8 / EFO8	2.4	8	90	1219	48	1219	48	1700	60
EF10 / EFO10	3.0	10	90	1828	72	1828	72	2830	100
EF12 / EFO12	3.6	12	90	1828	72	1828	72	2830	100

SCOUR PREVENTION AND ONLINE CONFIGURATION

► Stormceptor® EF and EFO feature an internal bypass and superior scour prevention technology that have been demonstrated in third-party testing according to the scour testing provisions of the Canadian ETV **Procedure for Laboratory Testing of Oil-Grit Separators**, and the exceptional scour test performance has been third-party verified in accordance with the ISO 14034 ETV protocol. As a result, Stormceptor EF and EFO are approved for online installation, eliminating the need for costly additional bypass structures, piping, and installation expense.

DESIGN FLEXIBILITY

► Stormceptor® EF and EFO offers design flexibility in one simplified platform, accepting stormwater flow from a single inlet pipe or multiple inlet pipes, and/or surface runoff through an inlet grate. The device can also serve as a junction structure, accommodate a 90-degree inlet-to-outlet bend angle, and can be modified to ensure performance in submerged conditions.

OIL CAPTURE AND RETENTION

► While Stormceptor® EF will capture and retain oil from dry weather spills and low intensity runoff, Stormceptor® EFO has demonstrated superior oil capture and greater than 99% oil retention in third-party testing according to the light liquid re-entrainment testing provisions of the Canadian ETV **Procedure for Laboratory Testing of Oil-Grit Separators**. Stormceptor EFO is recommended for sites where oil capture and retention is a requirement.

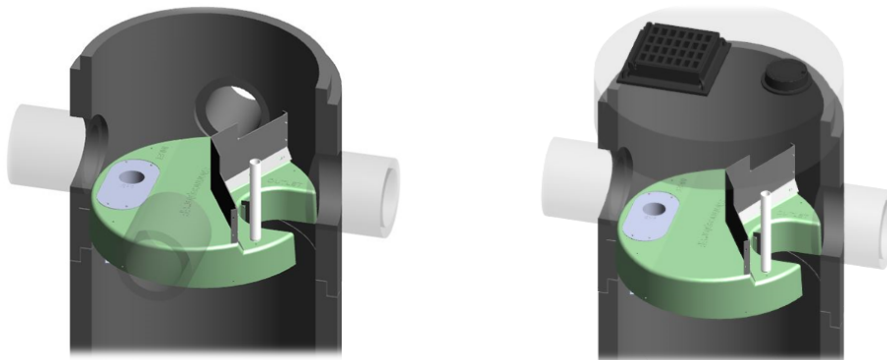

Stormceptor® EF Sizing Report

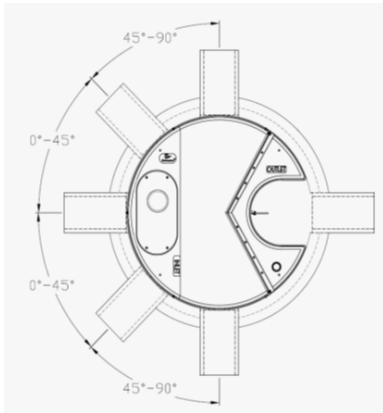

INLET-TO-OUTLET DROP

Elevation differential between inlet and outlet pipe inverts is dictated by the angle at which the inlet pipe(s) enters the unit.

0° - 45° : The inlet pipe is 1-inch (25mm) higher than the outlet pipe.

45° - 90° : The inlet pipe is 2-inches (50mm) higher than the outlet pipe.

HEAD LOSS

The head loss through Stormceptor EF is similar to that of a 60-degree bend structure. The applicable K value for calculating minor losses through the unit is 1.1.

For submerged conditions the applicable K value is 3.0.

Pollutant Capacity

Stormceptor EF / EFO	Model Diameter		Depth (Outlet Pipe Invert to Sump Floor)		Oil Volume		Recommended Sediment Maintenance Depth *		Maximum Sediment Volume *		Maximum Sediment Mass **	
	(m)	(ft)	(m)	(ft)	(L)	(Gal)	(mm)	(in)	(L)	(ft³)	(kg)	(lb)
EF4 / EFO4	1.2	4	1.52	5.0	265	70	203	8	1190	42	1904	5250
EF6 / EFO6	1.8	6	1.93	6.3	610	160	305	12	3470	123	5552	15375
EF8 / EFO8	2.4	8	2.59	8.5	1070	280	610	24	8780	310	14048	38750
EF10 / EFO10	3.0	10	3.25	10.7	1670	440	610	24	17790	628	28464	78500
EF12 / EFO12	3.6	12	3.89	12.8	2475	655	610	24	31220	1103	49952	137875

*Increased sump depth may be added to increase sediment storage capacity

** Average density of wet packed sediment in sump = 1.6 kg/L (100 lb/ft³)

Feature	Benefit	Feature Appeals To
Patent-pending enhanced flow treatment and scour prevention technology	Superior, verified third-party performance	Regulator, Specifying & Design Engineer
Third-party verified light liquid capture and retention for EFO version	Proven performance for fuel/oil hotspot locations	Regulator, Specifying & Design Engineer, Site Owner
Functions as bend, junction or inlet structure	Design flexibility	Specifying & Design Engineer
Minimal drop between inlet and outlet	Site installation ease	Contractor
Large diameter outlet riser for inspection and maintenance	Easy maintenance access from grade	Maintenance Contractor & Site Owner

STANDARD STORMCEPTOR EF/EFO DRAWINGS

For standard details, please visit <http://www.imbriumsystems.com/stormwater-treatment-solutions/stormceptor-ef>

STANDARD STORMCEPTOR EF/EFO SPECIFICATION

For specifications, please visit <http://www.imbriumsystems.com/stormwater-treatment-solutions/stormceptor-ef>

Stormceptor® **EF** Sizing Report

**STANDARD PERFORMANCE SPECIFICATION FOR
“OIL GRIT SEPARATOR” (OGS) STORMWATER QUALITY TREATMENT DEVICE**

PART 1 – GENERAL

1.1 WORK INCLUDED

This section specifies requirements for selecting, sizing, and designing an underground Oil Grit Separator (OGS) device for stormwater quality treatment, with third-party testing results and a Statement of Verification in accordance with ISO 14034 Environmental Management – Environmental Technology Verification (ETV).

1.2 REFERENCE STANDARDS & PROCEDURES

ISO 14034:2016 Environmental management – Environmental technology verification (ETV)

Canadian Environmental Technology Verification (ETV) Program’s **Procedure for Laboratory Testing of Oil-Grit Separators**

1.3 SUBMITTALS

1.3.1 All submittals, including sizing reports & shop drawings, shall be submitted upon request with each order to the contractor then forwarded to the Engineer of Record for review and acceptance. Shop drawings shall detail all OGS components, elevations, and sequence of construction.

1.3.2 Alternative devices shall have features identical to or greater than the specified device, including: treatment chamber diameter, treatment chamber wet volume, sediment storage volume, and oil storage volume.

1.3.3 Unless directed otherwise by the Engineer of Record, OGS stormwater quality treatment product substitutions or alternatives submitted within ten days prior to project bid shall not be accepted. All alternatives or substitutions submitted shall be signed and sealed by a local registered Professional Engineer, based on the exact same criteria detailed in Section 3, in entirety, subject to review and approval by the Engineer of Record.

PART 2 – PRODUCTS

2.1 OGS POLLUTANT STORAGE

The OGS device shall include a sump for sediment storage, and a protected volume for the capture and storage of petroleum hydrocarbons and buoyant gross pollutants. The minimum sediment & petroleum hydrocarbon storage capacity shall be as follows:

2.1.1	4 ft (1219 mm) Diameter OGS Units:	1.19 m ³ sediment / 265 L oil
	6 ft (1829 mm) Diameter OGS Units:	3.48 m ³ sediment / 609 L oil
	8 ft (2438 mm) Diameter OGS Units:	8.78 m ³ sediment / 1,071 L oil
	10 ft (3048 mm) Diameter OGS Units:	17.78 m ³ sediment / 1,673 L oil
	12 ft (3657 mm) Diameter OGS Units:	31.23 m ³ sediment / 2,476 L oil

PART 3 – PERFORMANCE & DESIGN

3.1 GENERAL

The OGS stormwater quality treatment device shall be verified in accordance with ISO 14034:2016 Environmental management – Environmental technology verification (ETV). The OGS stormwater quality treatment device shall



Stormceptor® EF Sizing Report

remove oil, sediment and gross pollutants from stormwater runoff during frequent wet weather events, and retain these pollutants during less frequent high flow wet weather events below the insert within the OGS for later removal during maintenance. The Manufacturer shall have at least ten (10) years of local experience, history and success in engineering design, manufacturing and production and supply of OGS stormwater quality treatment device systems, acceptable to the Engineer of Record.

3.2 SIZING METHODOLOGY

The OGS device shall be engineered, designed and sized to provide stormwater quality treatment based on treating a minimum of 90 percent of the average annual runoff volume and a minimum removal of an annual average 60% of the sediment (TSS) load based on the Particle Size Distribution (PSD) specified in the sizing report for the specified device. Sizing of the OGS shall be determined by use of a minimum ten (10) years of local historical rainfall data provided by Environment Canada. Sizing shall also be determined by use of the sediment removal performance data derived from the ISO 14034 ETV third-party verified laboratory testing data from testing conducted in accordance with the Canadian ETV protocol Procedure for Laboratory Testing of Oil-Grit Separators, as follows:

3.2.1 Sediment removal efficiency for a given surface loading rate and its associated flow rate shall be based on sediment removal efficiency demonstrated at the seven (7) tested surface loading rates specified in the protocol, ranging 40 L/min/m² to 1400 L/min/m², and as stated in the ISO 14034 ETV Verification Statement for the OGS device.

3.2.2 Sediment removal efficiency for surface loading rates between 40 L/min/m² and 1400 L/min/m² shall be based on linear interpolation of data between consecutive tested surface loading rates.

3.2.3 Sediment removal efficiency for surface loading rates less than the lowest tested surface loading rate of 40 L/min/m² shall be assumed to be identical to the sediment removal efficiency at 40 L/min/m². No extrapolation shall be allowed that results in a sediment removal efficiency that is greater than that demonstrated at 40 L/min/m².

3.2.4 Sediment removal efficiency for surface loading rates greater than the highest tested surface loading rate of 1400 L/min/m² shall assume zero sediment removal for the portion of flow that exceeds 1400 L/min/m², and shall be calculated using a simple proportioning formula, with 1400 L/min/m² in the numerator and the higher surface loading rate in the denominator, and multiplying the resulting fraction times the sediment removal efficiency at 1400 L/min/m².

The OGS device shall also have sufficient annual sediment storage capacity as specified and calculated in Section 2.1.

3.3 CANADIAN ETV or ISO 14034 ETV VERIFICATION OF SCOUR TESTING

The OGS device shall have Canadian ETV or ISO 14034 ETV Verification of third-party scour testing conducted in accordance with the Canadian ETV Program's **Procedure for Laboratory Testing of Oil-Grit Separators**.

3.3.1 To be acceptable for on-line installation, the OGS device must demonstrate an average scour test effluent concentration less than 10 mg/L at each surface loading rate tested, up to and including 2600 L/min/m².

3.4 LIGHT LIQUID RE-ENTRAINMENT SIMULATION TESTING

The OGS device shall have Canadian ETV or ISO 14034 ETV Verification of completed third-party Light Liquid Re-entrainment Simulation Testing in accordance with the Canadian ETV **Program's Procedure for Laboratory Testing of Oil-Grit Separators**, with results reported within the Canadian ETV or ISO 14034 ETV verification. This re-entrainment testing is conducted with the device pre-loaded with low density polyethylene (LDPE) plastic beads as a surrogate for light liquids such as oil and fuel. Testing is conducted on the same OGS unit tested for sediment removal to

Stormceptor® EF Sizing Report

assess whether light liquids captured after a spill are effectively retained at high flow rates.

3.4.1 For an OGS device to be an acceptable stormwater treatment device on a site where vehicular traffic occurs and the potential for an oil or fuel spill exists, the OGS device must have reported verified performance results of greater than 99% cumulative retention of LDPE plastic beads for the five specified surface loading rates (ranging 200 L/min/m² to 2600 L/min/m²) in accordance with the Light Liquid Re-entrainment Simulation Testing within the Canadian ETV Program's **Procedure for Laboratory Testing of Oil-Grit Separators**. However, an OGS device shall not be allowed if the Light Liquid Re-entrainment Simulation Testing was performed with screening components within the OGS device that are effective at retaining the LDPE plastic beads, but would not be expected to retain light liquids such as oil and fuel.

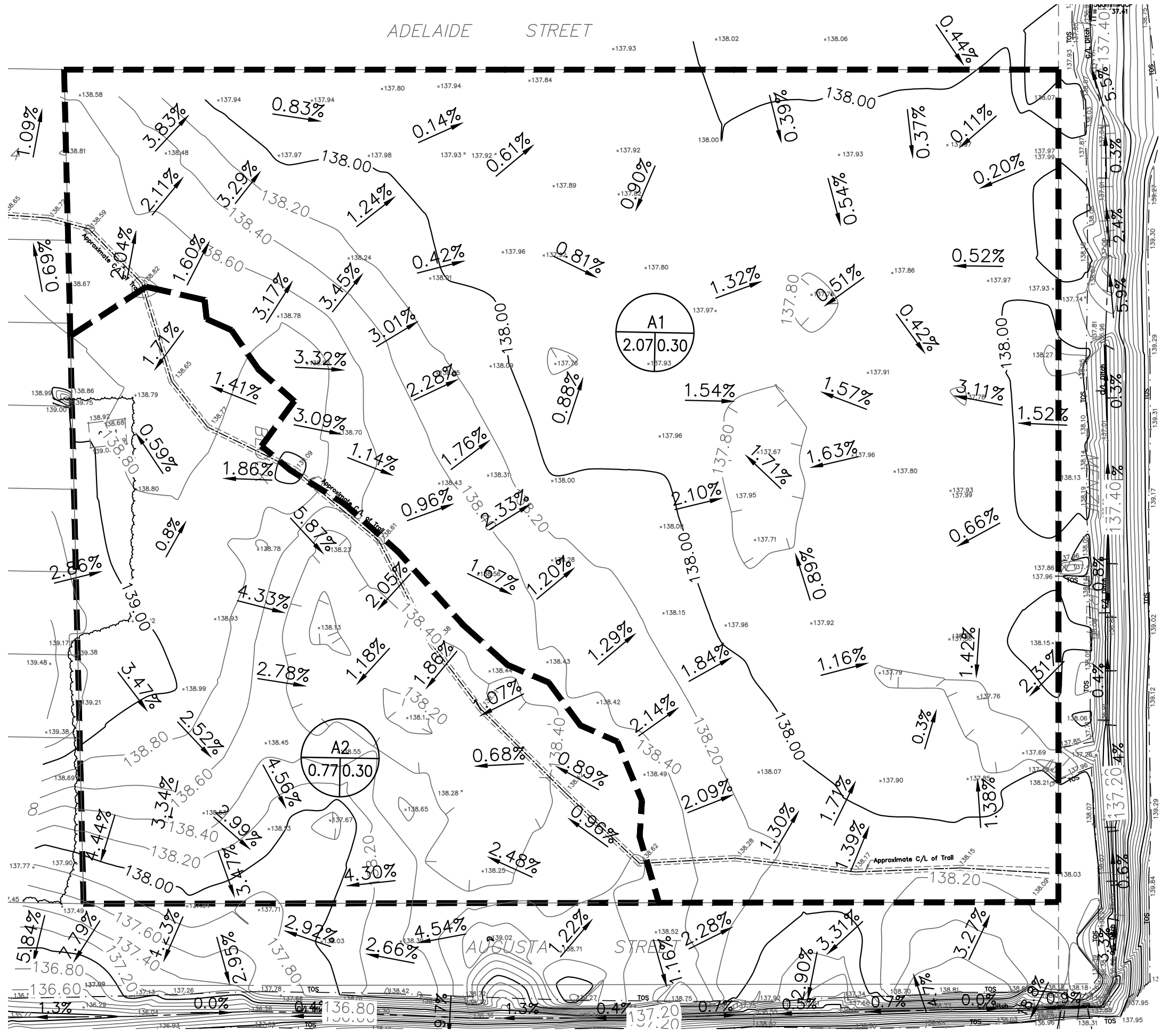

ADELAIDE STREET

AUGUSTA STREET

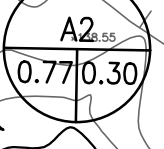
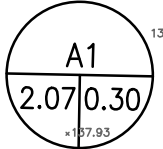

LEGEND:

- STORM DRAINAGE BOUNDARY 2.00%
- DRAINAGE PATTERN 2.00%
- DRAINAGE AREA ID A#
- AREA IN HECTARES 0.77/0.25
- RUNOFF COEFFICIENT 0.4
- TEST PIT TP
- CONTOUR 138.00

PRE-DEVELOPMENT DRAINAGE AREAS

Area Table	
Area ID	Area m ²
A1	20689
A2	7732
TOTAL	28426

DRAWING TITLE:
**DRAINAGE AREAS
 PRE-DEVELOPMENT**

PROJECT NAME AND ADDRESS:
 RESIDENTIAL SUBDIVISION
 ALMONTE - MISSISSIPPI MILLS

SCALE: 1:750
 DATE: 1/26/23

DRAWING No.:
ST-1

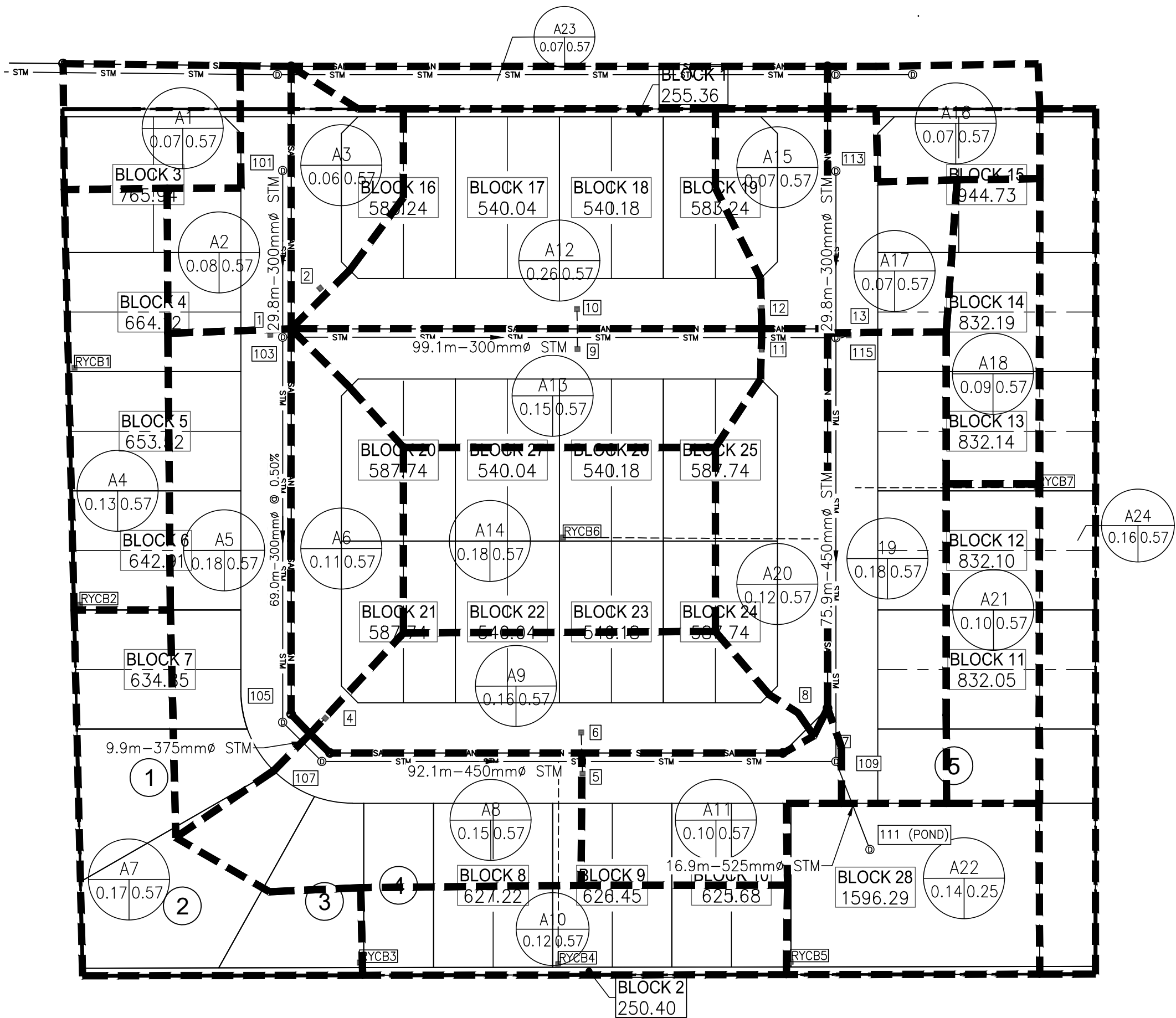

LEGEND:

- STORM DRAINAGE BOUNDARY
- UPSTREAM MH TO DOWNSTREAM MH
- AREA IN HECTARES
- RUNOFF COEFFICIENT
- EXTERNAL 2.78AC =
- EXTERNAL TIME OF CONCENTRATION
- EXTERNAL BLENDED RUNOFF COEFFICIENT
- UPSTREAM MH TO DOWNSTREAM MH
- AREA IN OTHER PHASES IN HECTARES
- RUNOFF COEFFICIENT

CATCHMENT	AREA m ²
A1	703
A2	765.4
A3	619.2
A4	1342.2
A5	1816.8
A6	1096.6
A7	1710.7
A8	1527.75
A9	1619.2
A10	1215.7
A11	992.2
A12	2558.3
A13	1518.5
A14	1849.6
A15	652.3
A16	666.7
A17	717.1
A18	883.5
A19	1759.2
A20	1175.4
A21	953.3
A22	1385.5
A23	686.7
A24	1555.78
TOTAL	29770.6

DRAWING TITLE:
**DRAINAGE AREAS
 POST-DEVELOPMENT**

PROJECT NAME AND ADDRESS:
 RESIDENTIAL SUBDIVISION
 ALMONTE - MISSISSIPPI MILLS

SCALE: 1:750
 DATE: 2/4/23

DRAWING No.:
ST-2

Ottawa Sewer Guidelines Model

STORM SEWER DESIGN CALCULATION SHEET (RATIONAL METHOD)

Return frequency = 5 years

LOCATION				RUNOFF FLOW							SEWER DESIGN								
1	2	3	4	5	6	7	8	9	10	11	12	13	14	15	16	17	18	19	20
Street Name	From JUNC.	To JUNC.	Catchment	Indiv Area (ha)	Indiv R (See tables)	Indiv.	Accum.	Time of Conc. (min)	Rainfall Intensity (mm/hr)	Peak Flow Q _p (m ³ /s)	Pipe Nominal Dia. (mm)	Pipe Actual Int. Dia. (mm)	Type of Pipe	Slopes %	Length (m)	Pipe Capacity Q _r (m ³ /s)	Full Flow Velocity V _r (m/s)	Time of Flow (min)	Q _p / Q _r %
						2.78 AR	2.78 AR												
Street A	101	103	A1	0.0703	0.57	0.11	0.11	10.00	104.2	0.034	300	300	DR35	0.65	29.8	0.078	1.10	0.45	44%
			A2	0.0765	0.57	0.12	0.23												
			A3	0.0619	0.57	0.10	0.33												
Street A	103	105	A4	0.1342	0.57	0.21	0.54	10.45	101.9	0.055	300	300	DR35	0.50	69.0	0.068	0.97	1.19	81%
Street A	105	107	A5	0.1817	0.57	0.29	0.83	11.64	96.3	0.097	375	381	DR35	0.50	9.9	0.129	1.13	0.15	75%
			A6	0.1097	0.57	0.17	1.01												
Street A	107	109	A7	0.1711	0.57	0.27	1.28	11.78	95.6	0.203	450	457	Conc.	0.55	92.1	0.220	1.34	1.14	92%
			A8	0.1528	0.57	0.24	1.52												
			A9	0.1619	0.57	0.26	1.77												
			A10	0.1216	0.57	0.19	1.97												
			A11	0.0992	0.57	0.16	2.12												
Street B	103	115	A12	0.2558	0.57	0.41	0.41	10.00	104.2	0.067	300	300	DR35	0.65	99.1	0.078	1.10	1.50	86%
			A13	0.1519	0.57	0.24	0.65												
Street A	113	115	A23	0.0687	0.57	0.11	0.11	10.00	104	0.011	300	300	DR35	0.65	29.8	0.078	1.10	0.45	15%

AT MH 115 FLOW FROM MH 103 AND MH113

0.75	11.50	96.9	0.073
------	-------	------	-------

Street A	115	109	A14	0.1850	0.57	0.29	1.05	11.50	96.9	0.206	450	457	Conc.	0.55	75.9	0.220	1.34	0.94	94%
			A15	0.0652	0.57	0.10	1.15												
			A16	0.0667	0.57	0.11	1.26												
			A17	0.0717	0.57	0.11	1.37												
			A18	0.0884	0.57	0.14	1.51												
			A19	0.1759	0.57	0.28	1.79												
			A20	0.1175	0.57	0.19	1.98												
			A21	0.0953	0.57	0.15	2.13												

MH 109 FROM MH 107 AND MH115 TO STM FACILITY

4.25	12.93	90.9	0.387	525	531	Conc.	1.00	17.5	0.443	2.00	0.15	87%
------	-------	------	-------	-----	-----	-------	------	------	-------	------	------	-----

AT STM FACILITY OUTFALL FROM MH 109

4.25	13.07	90.3	0.384
------	-------	------	-------

Definitions:

Q = Peak Flow in Litres per Second (L/s)
 $Q = 2.78 * A * I * R$, where
 Q = Peak Flow in Litres per Second (L/s)
 A = Areas in hectares (ha)
 I = Rainfall Intensity (mm/h)
 R = Runoff Coefficient

Notes:

1- Manning formula used to calculate flow capacities
 2- Hydraulic Toolbox software was used to calculate capacities and depths of flows
 3- No projected carryover flow from east and west sides of the property
 4- Minimum Tc is 10 min as per Ottawa Design Guidelines
 5- Minimum permissible velocity in sewer: 0.76 m/s
 $Q_{full} = 23.976 \times D^{8/3} \times S^{1/2}$ (for n = 0.013, D in metres)
 Full flow velocity: $V_{full} = 30.527 \times D^{2/3} \times S^{1/2}$ (for n = 0.013, D in metres)

Hydraulic Design

Roughness coefficient (n) in Manning equation:
 PVC Pipe (DR35): n = 0.013
 Concrete Pipe: n = 0.013
 Concrete Culvert (smooth): n= 0.013
 Grassed Channel: n=0.035

Rainfall Intensity Curves for Ottawa:

5 year rainfall intensity: $I_5 = (998.071)/((T_c + 6.053)^{0.814})$
 25 year rainfall intensity: $I_{25} = (1402.884)/((T_c + 6.018)^{0.819})$
 50 year rainfall intensity: $I_{50} = (1569.58)/((T_c + 6.014)^{0.82})$
 100 year rainfall intensity: $I_{100} = (1735.688)/((T_c + 6.014)^{0.82})$

A22: STORMWATER FACILITY C=0.25

A24: BUFFER ZONE, DRAINS DIRECTLY TO THE CREEK

A16: ADELAIDE STREET, WILL BE DESIGNED BY HANNAN HILLS TEAM BUT INCLUDED FOR CONSERVATIVE DESIGN